

## PART 3. MARKINGS

<b>CHAPTER 3A. GENERAL</b>	<b>PAGE</b>
Section 3A.01 Functions and Limitations	
Section 3A.02 Standardization of Application	
Section 3A.03 Maintaining Minimum Pavement Marking Retroreflectivity	
Section 3A.04 Materials .....	3-1
Section 3A.05 Colors .....	3-1
Section 3A.06 Functions, Widths, and Patterns of Longitudinal Pavement Markings .....	3-2
<b>CHAPTER 3B. PAVEMENT AND CURB MARKINGS</b>	<b>PAGE</b>
Section 3B.01 Yellow Center Line Pavement Markings and Warrants .....	3-5
Section 3B.02 No Passing Zone Pavement Markings and Warrants	
Section 3B.03 Other Yellow Longitudinal Pavement Markings	
Section 3B.04 White Lane Line Pavement Markings and Warrants .....	3-10
Section 3B.05 Other White Longitudinal Pavement Markings .....	3-25
Section 3B.06 Edge Line Pavement Markings .....	3-29
Section 3B.07 Warrants for Use of Edge Lines .....	3-30
Section 3B.08 Extensions through Intersections or Interchanges .....	3-31
Section 3B.09 Lane Reduction Transition Markings .....	3-36
Section 3B.10 Approach Markings for Obstructions	
Section 3B.11 Raised Pavement Markers – General .....	3-38
Section 3B.12 Raised Pavement Markers as Vehicle Positioning Guides with Other Longitudinal Markings .....	3-43
Section 3B.13 Raised Pavement Markers Supplementing Other Markings .....	3-44
Section 3B.14 Raised Pavement Markers Substituting for Pavement Markings .....	3-46
Section 3B.15 Transverse Markings	
Section 3B.16 Stop and Yield Lines .....	3-46
Section 3B.17 Do Not Block Intersection Markings	
Section 3B.18 Crosswalk Markings .....	3-48
Section 3B.19 Parking Space Markings .....	3-52
Section 3B.20 Pavement Word, Symbol, and Arrow Markings .....	3-53
Section 3B.21 Speed Measurement Markings .....	3-63
Section 3B.22 Speed Reduction Markings	
Section 3B.23 Curb Markings	
Section 3B.24 Chevron and Diagonal Crosshatch Markings .....	3-65
Section 3B.25 Speed Hump Markings	
Section 3B.26 Advance Speed Hump Markings	



Section 3B.V1 Breaks in Longitudinal Lines at Intersections .....	3-67
---	------

<b>CHAPTER 3C. ROUNDABOUT MARKINGS</b>	<b>PAGE</b>
--	-------------

Section 3C.01 General	
Section 3C.02 White Lane Line Pavement Markings for Roundabouts	
Section 3C.03 Edge Line Pavement Markings for Roundabout Circulatory Roadways	
Section 3C.04 Yield Lines for Roundabouts	
Section 3C.05 Crosswalk Markings at Roundabouts	
Section 3C.06 Word, Symbol, and Arrow Pavement Markings for Roundabouts	
Section 3C.07 Markings for Other Circular Intersections	

<b>CHAPTER 3D. MARKINGS FOR PREFERENTIAL LANES</b>	<b>PAGE</b>
--	-------------

Section 3D.01 Preferential Lane Word and Symbol Markings .....	3-68
Section 3D.02 Preferential Lane Longitudinal Markings for Motor Vehicles .....	3-70

<b>CHAPTER 3E. MARKINGS FOR TOLL PLAZAS</b>	<b>PAGE</b>
---	-------------

Section 3E.01 Markings for Toll Plazas	
--	--

<b>CHAPTER 3F. DELINEATORS</b>	<b>PAGE</b>
--------------------------------	-------------

Section 3F.01 Delineators	
Section 3F.02 Delineator Design .....	3-78
Section 3F.03 Delineator Application .....	3-78
Section 3F.04 Delineator Placement and Spacing .....	3-81

<b>CHAPTER 3G. COLORED PAVEMENTS</b>	<b>PAGE</b>
--------------------------------------	-------------

Section 3G.01 General	
-----------------------	--

<b>CHAPTER 3H. CHANNELIZING DEVICES USED FOR EMPHASIS OF PAVEMENT MARKING PATTERNS</b>	<b>PAGE</b>
--	-------------

Section 3H.01 Channelizing Devices	
------------------------------------	--

<b>CHAPTER 3I. ISLANDS</b>	<b>PAGE</b>
----------------------------	-------------

Section 3I.01 General	
Section 3I.02 Approach End Treatment	
Section 3I.03 Island Marking Application	
Section 3I.04 Island Marking Colors	

Section 3I.05 Island Delineation

Section 3I.06 Pedestrian Islands and Medians

**CHAPTER 3J. RUMBLE STRIP MARKINGS** **PAGE**

---

Section 3J.01 Longitudinal Rumble Strip Markings

Section 3J.02 Transverse Rumble Strip Markings

# PART 3

## MARKINGS

### CHAPTER 3A. GENERAL

#### Section 3A.04 Materials

**Support:**

- 01 Pavement and curb markings are commonly placed by using paints or thermoplastics; however, other suitable marking materials, including raised pavement markers and colored pavements, are also used. Delineators and channelizing devices are visibly placed in a vertical position similar to signs above the roadway.
- 02 Some marking systems consist of clumps or droplets of material with visible open spaces of bare pavement between the material droplets. These marking systems can function in a manner that is similar to the marking systems that completely cover the pavement surface and are suitable for use as pavement markings if they meet the other pavement marking requirements of the highway agency.

**Guidance:**

- 03 *The materials used for markings should provide the specified color throughout their useful life.*
- 04 *Consideration should be given to selecting pavement marking materials that will minimize tripping or loss of traction for road users, including pedestrians, bicyclists, and motorcyclists.*
- 05 *Delineators should not present a vertical or horizontal clearance obstacle for pedestrians.*

**Support:**

- 06 Information regarding the materials used for pavement markings in Virginia can be found in VDOT's latest "Road and Bridge Specifications" ([link provided in Appendix A of this Supplement](#)).



#### Section 3A.05 Colors

**Standard:**

- 01 **Markings shall be yellow, white, red, blue, or purple. The colors for markings shall conform to the standard highway colors. Black in conjunction with one of the colors mentioned in the first sentence of this paragraph shall be a usable color.**
- 02 **When used, white markings for longitudinal lines shall delineate:**
  - A. **The separation of traffic flows in the same direction, or**
  - B. **The right-hand edge of the roadway.**

- 03 **When used, yellow markings for longitudinal lines shall delineate:**
- A. **The separation of traffic traveling in opposite directions,**
  - B. **The left-hand edge of the roadways of divided highways and one-way streets or ramps, or**
  - C. **The separation of two-way left-turn lanes and reversible lanes from other lanes.**
- 04 **When used, red raised pavement markers or delineators shall delineate:**
- A. **Truck escape ramps, or**
  - B. **One-way roadways, ramps, or travel lanes that shall not be entered or used in the direction from which the markers are visible.**
- 05 **When used, blue markings shall supplement white markings for parking spaces for persons with disabilities.**
- 06 **When used, purple markings shall supplement lane line or edge line markings for toll plaza approach lanes that are restricted to use only by vehicles with registered electronic toll collection accounts.**
- Option:
- 07 Colors used for official route shield signs (see [Section 2D.11 of this Supplement](#)) may be used as colors of symbol markings to simulate route shields on the pavement (see [Section 3B.20 of this Supplement](#)).
- Guidance:*
- 08 *The use of non-reflective black in combination with the colors mentioned in the first sentence of Paragraph 1, particularly with white markings, should be considered for concrete bridges and concrete pavement sections more than 75 feet in length with a posted speed limit of 25 mph or greater.*
- Option:
- 09 When used with broken white lines, the black may be used in one of two ways to help improve contrast:
- A. **As an outline around the white markings, or**
  - B. **In an alternating pattern with the white markings.**
- Support:
- 10 When used in combination with other colors, black is not considered a marking color, but only a contrast-enhancing system for the markings.



## **Section 3A.06 Functions, Widths, and Patterns of Longitudinal Pavement Markings**

### **Standard:**

- 01 **The general functions of longitudinal lines shall be:**
- A. **A double line indicates maximum or special restrictions,**

- B. A solid line discourages or prohibits crossing (depending on the specific application),
- C. A broken line indicates a permissive condition, and
- D. A dotted line provides guidance or warning of a downstream change in lane function.



02 The widths and patterns of longitudinal lines shall be as follows:

- A. Normal line—4 inches wide, except as provided in Paragraphs 9 through 11 below.
- B. Wide line—at least twice the width of a normal line.
- C. Double line—two parallel lines separated by a discernible space.
- D. Broken line—normal line segments separated by gaps.
- E. Dotted line—noticeably shorter line segments separated by shorter gaps than used for a broken line. The width of a dotted line extension shall be at least the same as the width of the line it extends.

03 Broken lines shall consist of 10-foot line segments and 30-foot gaps.

04 A dotted line for line extensions or taper areas at an intersection shall consist of 2-foot line segments and 4-foot gaps. A dotted line used for lane drop markings at intersections shall consist of 3-foot line segments and 9-foot gaps.

*Guidance:*

05 A dotted line used as a lane line at interchanges should consist of 3-foot line segments and 9-foot gaps

06 The space between two parallel lines should be a minimum of 4 inches wide and should be no less than 6 inches wide if raised pavement markers are present. Prior to installing new parallel lines, the need for raised pavement markers in the near future (e.g., prior to the next scheduled resurfacing) should be investigated to identify the most appropriate spacing that would also accommodate future installation of raised pavement markers.

*Support:*

07 The width of the line indicates the degree of emphasis.

08 Patterns for dotted lines depend on the application (see Sections 3B.04 and 3B.08 of this Supplement.)

**Standard:**

09 The through lanes of all freeways shall be marked with 6-inch wide normal lines except as noted in Paragraph 10. When using normal line pavement markings on such highways, all normal line markings, including lane lines and edge lines, shall be 6 inches wide.

*Guidance:*

10 The through lanes of other limited access highways should be marked with 6-inch wide normal lines except those short segments (approximately three miles or less) of limited access primary routes designed to take traffic around communities and built-up areas,



*unless the connecting non-limited access portions of that route are also marked with 6-inch wide traffic lines.*

Option:

- 11 Any other roadway or roadway segment, including ramps and loops, may be marked with 6-inch wide normal lane markings based upon engineering judgment. Roadways with travel lane widths less than 12 feet in width may be evaluated by the Engineer on a case-by-case basis to determine the appropriate pavement marking width.

## CHAPTER 3B. PAVEMENT AND CURB MARKINGS

### Section 3B.01 Yellow Center Line Pavement Markings and Warrants

**Standard:**

- 01 **Center line pavement markings, when used, shall be the pavement markings used to delineate the separation of traffic lanes that have opposite directions of travel on a roadway and shall be yellow.**

**Option:**

- 02 Center line pavement markings may be placed at a location that is not the geometric center of the roadway.
- 03 On roadways without continuous center line pavement markings, short sections may be marked with center line pavement markings to control the position of traffic at specific locations, such as around curves, over hills, on approaches to grade crossings, at grade crossings, and at bridges.

**Standard:**

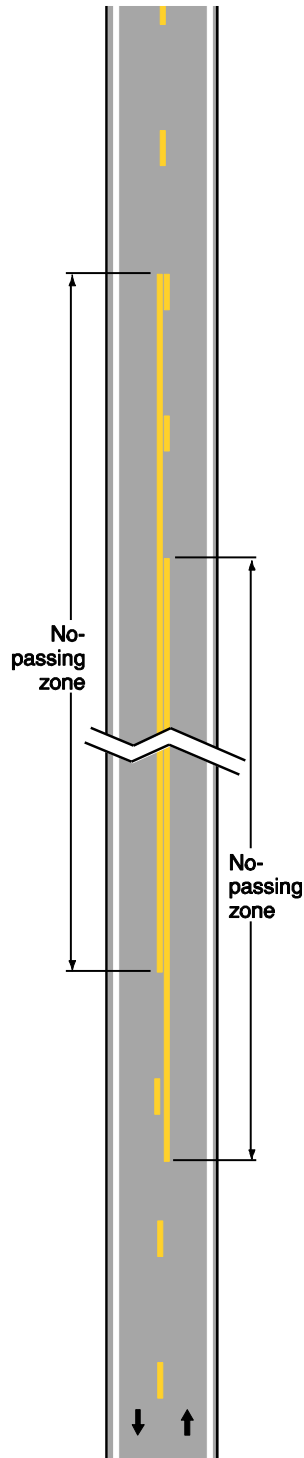
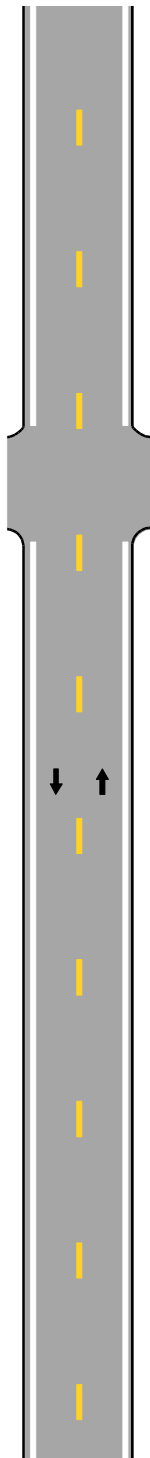
- 04 **The center line markings on two-lane, two-way roadways shall be one of the following as shown in Figure 3B-1:**
- A. **Two-direction passing zone markings consisting of a normal broken yellow line where crossing the center line markings for passing with care is permitted for traffic traveling in either direction;**
  - B. **One-direction no-passing zone markings consisting of a double yellow line, one of which is a normal broken yellow line and the other is a normal solid yellow line, where crossing the center line markings for passing with care is permitted for the traffic traveling adjacent to the broken line, but is prohibited for traffic traveling adjacent to the solid line; or**
  - C. **Two-direction no-passing zone markings consisting of two normal solid yellow lines where crossing the center line markings for passing is prohibited for traffic traveling in either direction.**
- 05 **A single solid yellow line shall not be used as a center line marking on a two-way roadway.**
- 06 **The center line markings on undivided two-way roadways with four or more lanes for moving motor vehicle traffic always available shall be the two-direction no-passing zone markings consisting of a solid double yellow line as shown in Figure 3B-2.**



# Figure 3B-1. Examples of Two-Lane, Two-Way Marking Applications

**A - Typical two-lane, two-way marking with passing permitted in both directions**

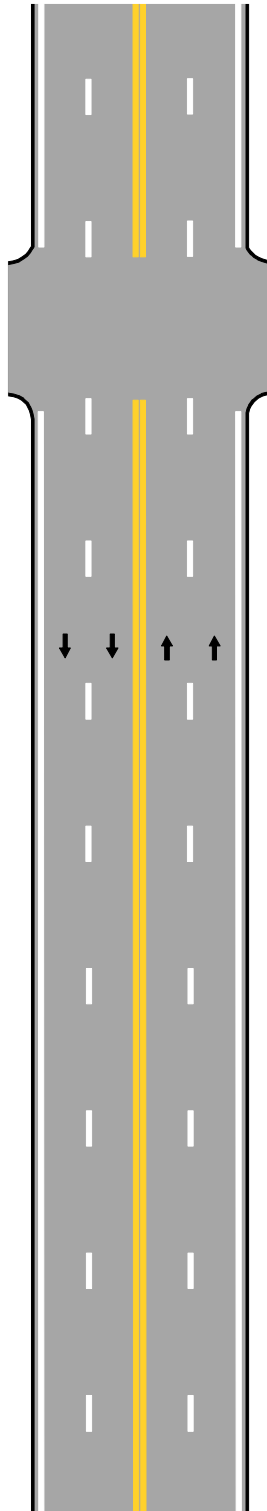
**B - Typical two-lane, two-way marking with no-passing zones**



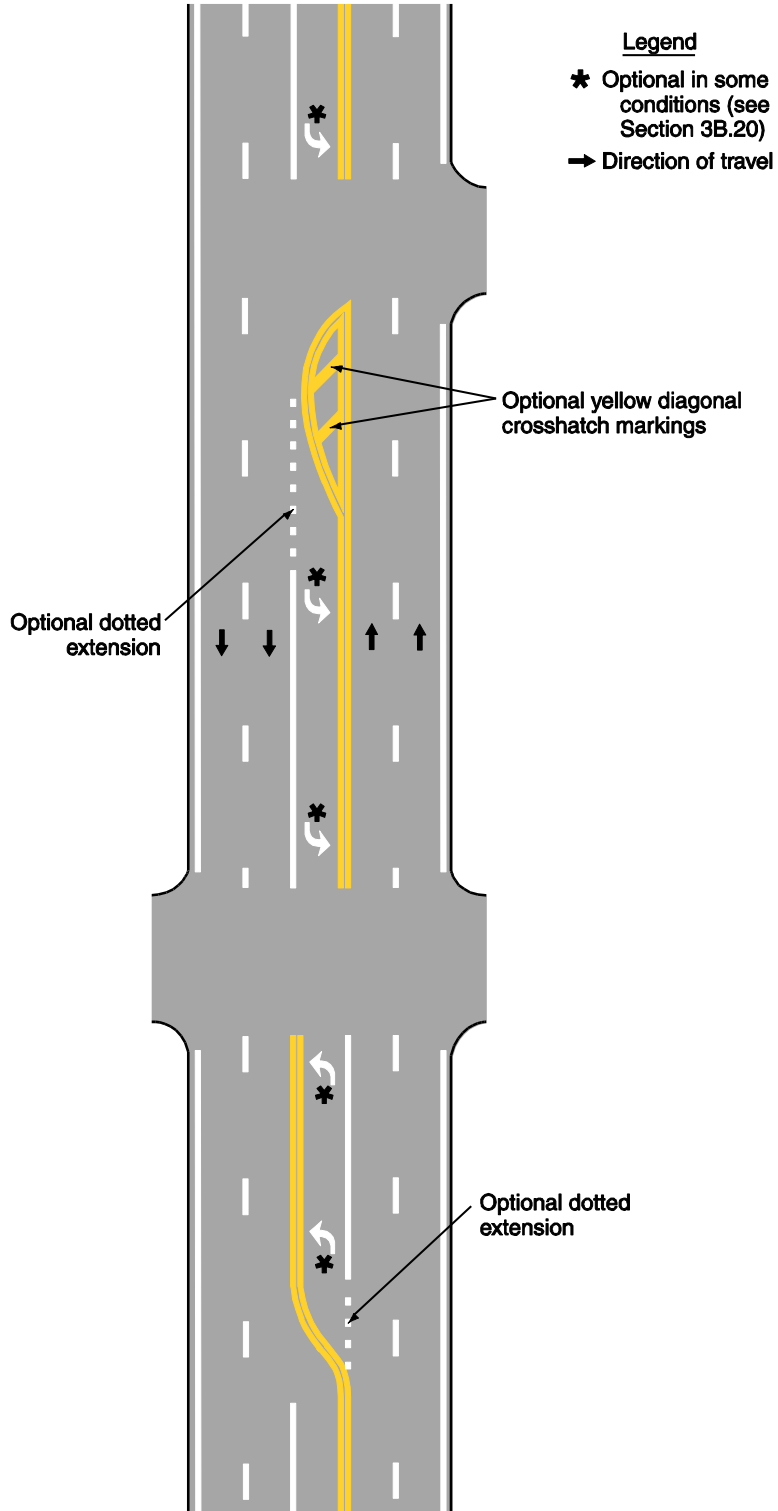
Legend  
→ Direction of travel

### Figure 3B-2. Examples of Four-or-More Lane, Two-Way Marking Applications

**A - Typical multi-lane, two-way marking**



**B - Typical multi-lane, two-way marking with single lane left turn channelization**



*Guidance:*

- 07 *On two-way roadways with three through lanes for moving motor vehicle traffic, two lanes should be designated for traffic in one direction by using one- or two-direction no-passing zone markings as shown in Figure 3B-3.*

*Support:*

- 08 Sections 11-301(c) and 11-311(c) of the "Uniform Vehicle Code (UVC)" contain information regarding left turns across center line no-passing zone markings and paved medians, respectively. The UVC can be obtained from the National Committee on Uniform Traffic Laws and Ordinances at the address shown on [Page i of the MUTCD](#).

*Guidance:*

- 09 *Breaks in center line markings should be made only at intersections with public roads, where the minor street has center line markings. Breaks should be of sufficient length to accommodate traffic entering or leaving the minor street.*

*Option:*

- 10 Breaks may be omitted in locations where the center line markings are needed for additional emphasis or delineation of the travel lanes, such as offset intersections or intersections located on horizontal or vertical curves.

*Guidance:*

- 11 *Breaks in center line markings should not be provided for low-volume public roadways or private road entrances.*
- 12 *If a segment of roadway containing an intersection with the conditions described in Paragraph 9 is marked with two-direction passing zone markings (see Paragraph 4) on one or both sides of the intersection, one direction no passing zone markings should be placed in the vicinity of the intersection to prohibit passing in the direction approaching the intersection.*

**Standard:**

- ~~13 **Center line markings shall be placed on all paved urban arterials and collectors that have a traveled way of 20 feet or more in width and an ADT of 6,000 vehicles per day or greater. Center line markings shall also be placed on all paved two-way streets or highways that have three or more lanes for moving motor vehicle traffic.**~~

*Guidance:*

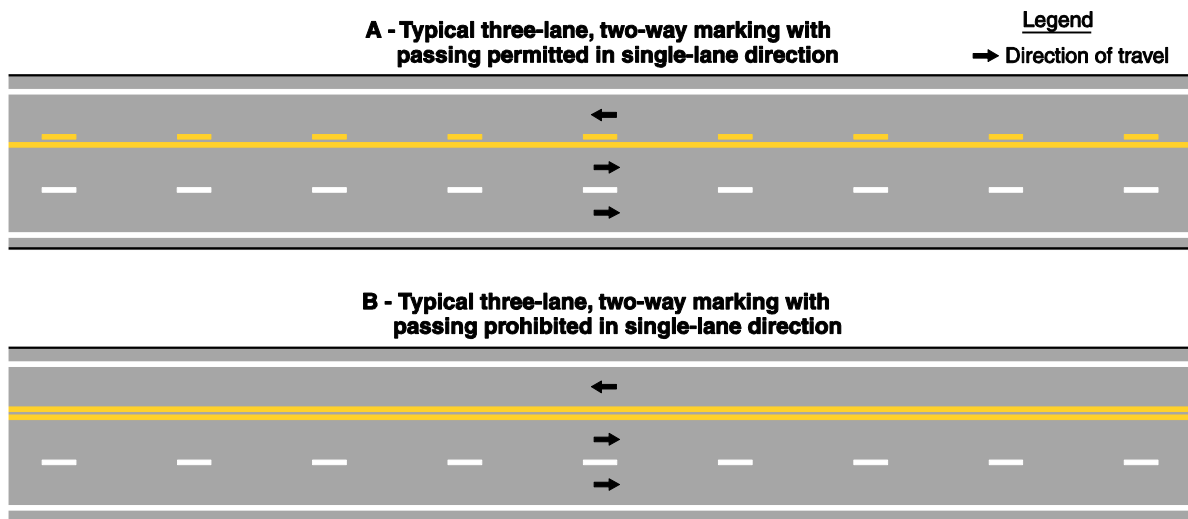
- ~~14 *Center line markings should be placed on paved urban arterials and collectors that have a traveled way of 20 feet or more in width and an ADT of 4,000 vehicles per day or greater. Center line markings should also be placed on all rural arterials and collectors that have a traveled way of 18 feet or more in width and an ADT of 3,000 vehicles per day or greater. Center line markings should also be placed on other traveled ways where an engineering study indicates such a need.*~~
- 15 *Engineering judgment should be used in determining whether to place center line markings on traveled ways that are less than 18 feet wide because of the potential for traffic encroaching on the pavement edges, traffic being affected by parked vehicles, and traffic encroaching into the opposing traffic lane.*



Option:

- ~~16 Center line markings may be placed on other paved two-way traveled ways that are 16 feet or more in width.~~
- 17 If a traffic count is not available, the ADTs described in this Section may be estimates that are based on engineering judgment.

## Figure 3B-3. Example of Three-Lane, Two-Way Marking Applications



**Standard:**

- 18 Except on local residential streets, center line markings shall be placed on each of the following:
- A. All undivided limited access highways;
  - B. All bi-directional multi-lane roadways; and
  - C. All other paved roadways with a pavement width of 18 feet or greater, and traffic volume equal to or greater than 500 vehicles per day.

**Support:**

- 19 Center line pavement markings are required on these roadway types according to the 1994 House Joint Resolution # 243.

**Guidance:**

- 20 If a section of roadway requires center line markings, but it contains a relatively short segment that does not meet the requirements above, center line markings should be installed on the short segment for consistency.



**Option:**

- 21 Center line pavement markings may be placed on roadways satisfying Criterion C in Paragraph 18 above, but with fewer than 500 vehicles per day, if an engineering study determines that vehicle speeds, crash frequency, or other factors indicate that a center line is warranted.

**Support:**

- 22 Criteria for placement of center line markings are shown in Table 3B-V1.



**Table 3B-V1. Criteria For Placement of Center Line Markings**

Pavement Width	Traffic Volume	Roadway Type				
		Undivided Limited Access	Bi-Directional Multi-Lane	Other Non-Local Residential	Other Local Residential	Short Segments not Meeting Requirements Between Segments Meeting Requirements
≥ 18 feet	≥ 500 vpd	Required	Required	Required	Optional	Recommended
	< 500 vpd	Required	Required	Optional (if warranted)	Optional	Recommended
< 18 feet	≥ 500 vpd	Required	Required	May be considered only where Engineering Judgment determines a need		Recommended
	< 500 vpd	Required	Required			Recommended

## **Section 3B.04 White Lane Line Pavement Markings and Warrants**

**Standard:**

- 01 **When used, lane line pavement markings delineating the separation of traffic lanes that have the same direction of travel shall be white.**
- 02 **Lane line markings shall be used on all freeways and interstate highways.**

*Guidance:*

- 03 *Lane line markings should be used on all roadways that are intended to operate with two or more adjacent traffic lanes in the same direction of travel, except as otherwise required for reversible lanes. Lane line markings should also be used at congested locations where the roadway will accommodate more traffic lanes with lane line markings than without the markings.*

**Standard:**

- 04 **Except as provided in Paragraph 5, where crossing the lane line markings with care is permitted, the lane line markings shall consist of a normal broken white line.**

- 05 **A dotted white line marking shall be used as the lane line to separate a through lane that continues beyond the interchange or intersection from an adjacent lane for any of the following conditions:**
- A. A deceleration or acceleration lane,**
  - B. A through lane that becomes a mandatory exit or turn lane,**
  - C. An auxiliary lane 2 miles or less in length between an entrance ramp and an exit ramp, or**
  - D. An auxiliary lane 1 mile or less in length between two adjacent intersections.**

*Guidance:*

- 06 *For exit ramps, lane drops, and route splits, except in the case of tapered deceleration lanes, an 8-inch minimum solid white lane line should be installed upstream of the theoretical gore for a minimum length of 100 feet (see Drawings A and C of Figure 3B-8(VA) and all Drawings of Figure 3B-10(VA) in this Supplement).*
- 07 *For multi-lane exit ramps, an 8-inch minimum solid white lane line marking should be installed upstream of the theoretical gore for a minimum length of 100 feet and should extend onto the ramp to the physical gore (see Drawing C of Figure 3B-8(VA) and Drawing B of Figure 3B-10(VA) in this Supplement).*

*Option:*

- 08 *The length of the solid white line separating multiple lanes of an exit ramp (see Drawing B of Figure 3B-10(VA) in this Supplement) may be greater than 100 feet on the through lane section and may extend beyond the physical gore on the ramp based on engineering judgment.*
- 09 *For exit ramps with a tapered deceleration lane, a normal width dotted lane line may be installed from the upstream end of the taper to the theoretical gore, as shown in Drawing B of Figure 3B-8(VA) in this Supplement.*

*Option:*

- 10 *The length of the 8-inch minimum solid white lane line may be greater than 100 feet based on engineering judgment.*

**Standard:**

- 11 **For exit ramps with a parallel deceleration lane, a normal width dotted white lane line shall be installed from the upstream end of the taper to the upstream end of the 8-inch minimum solid white lane line (see Drawings A and C of Figure 3B-8(VA) in this Supplement).**

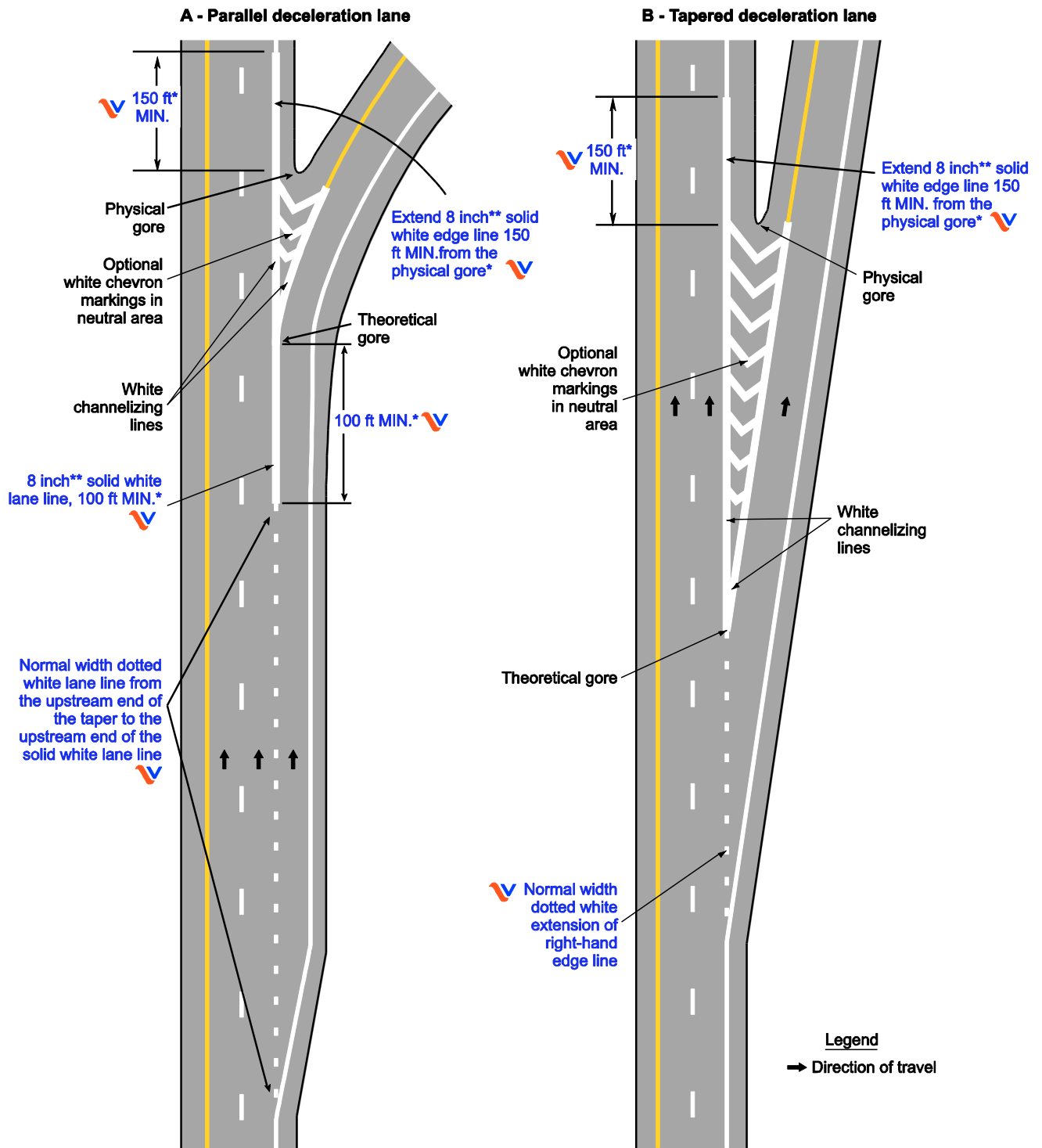
*Guidance:*

- 12 *For exit ramps or major route bifurcations, an 8-inch minimum solid white edge line downstream of the gore area should be installed a minimum of 150 feet beyond the physical gore (see Drawings A, B, and C of Figure 3B-8(VA) and Figure 3B-10(VA) in this Supplement).*
- 13 *For entrance ramps with a parallel acceleration lane, an 8-inch minimum solid white lane line should be installed downstream of the theoretical gore for a minimum of 100 feet (see Drawing A of Figure 3B-9(VA) in this Supplement).*

**Standard:**

- 14 **For entrance ramps with a parallel acceleration lane, a normal width dotted white lane line shall be installed from the downstream end of the 8-inch minimum solid white lane line to a point at least one-half the length of the full-width acceleration lane plus taper (see Drawing A of Figure 3B-9(VA) in this Supplement).**

**Figure 3B-8(VA). Example of Dotted Line and Channelizing Line Applications for Exit Ramp Markings (Sheet 1 of 2)**



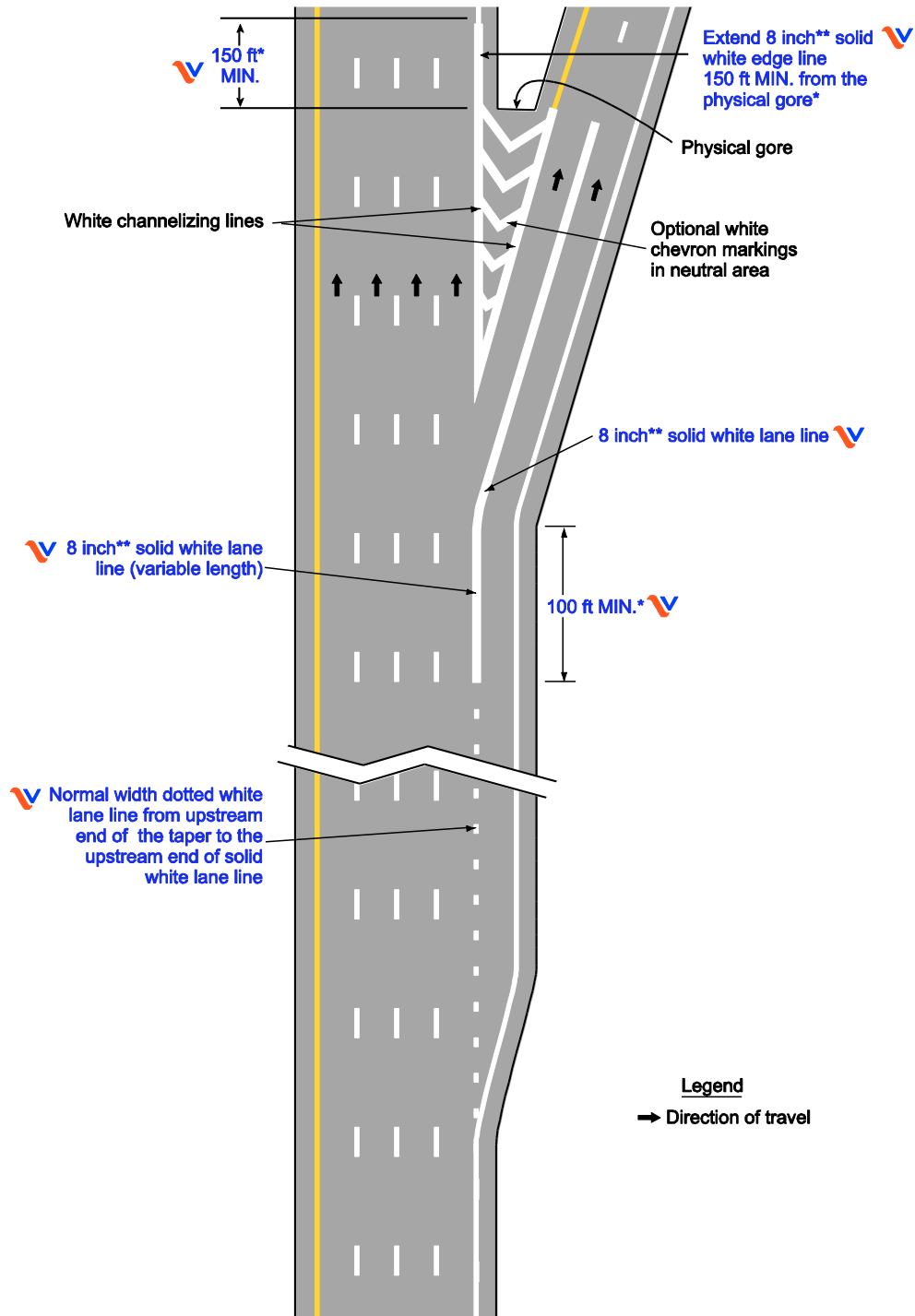
\*Minimums are recommended distances where spacing allows or is feasible

\*\*For all thicker emphasis lines in gore and lane drop areas, the width shall be 8 inches minimum.



## Figure 3B-8(VA). Example of Dotted Line and Channelizing Line Applications for Exit Ramp Markings (Sheet 2 of 2)

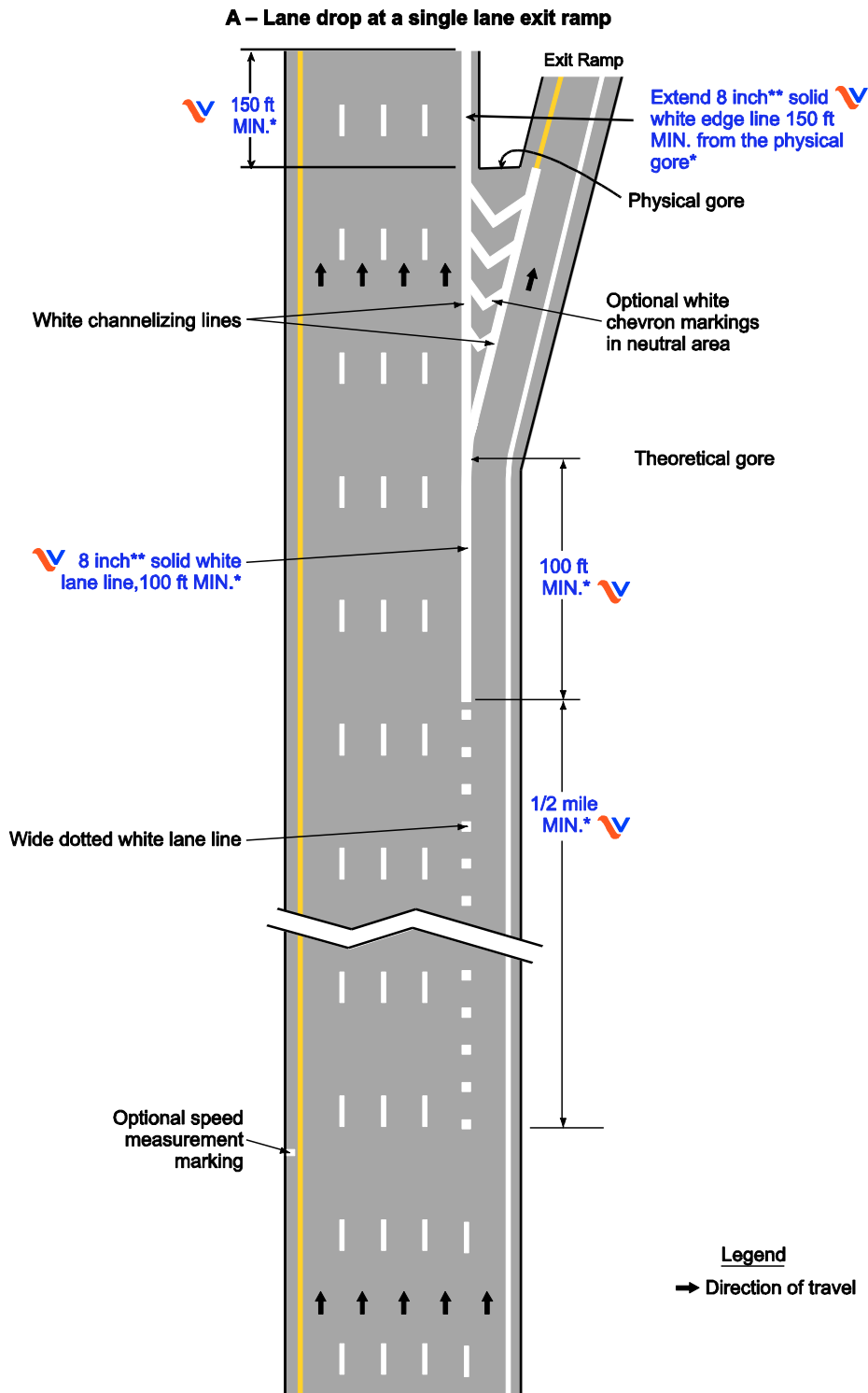
C – Parallel deceleration lane at a multi-lane exit ramp having an optional exit lane that also carries the through route



\*Minimums are recommended distances where spacing allows or is feasible

\*\*For all thicker emphasis lines in gore and lane drop areas, the width shall be 8 inches minimum.

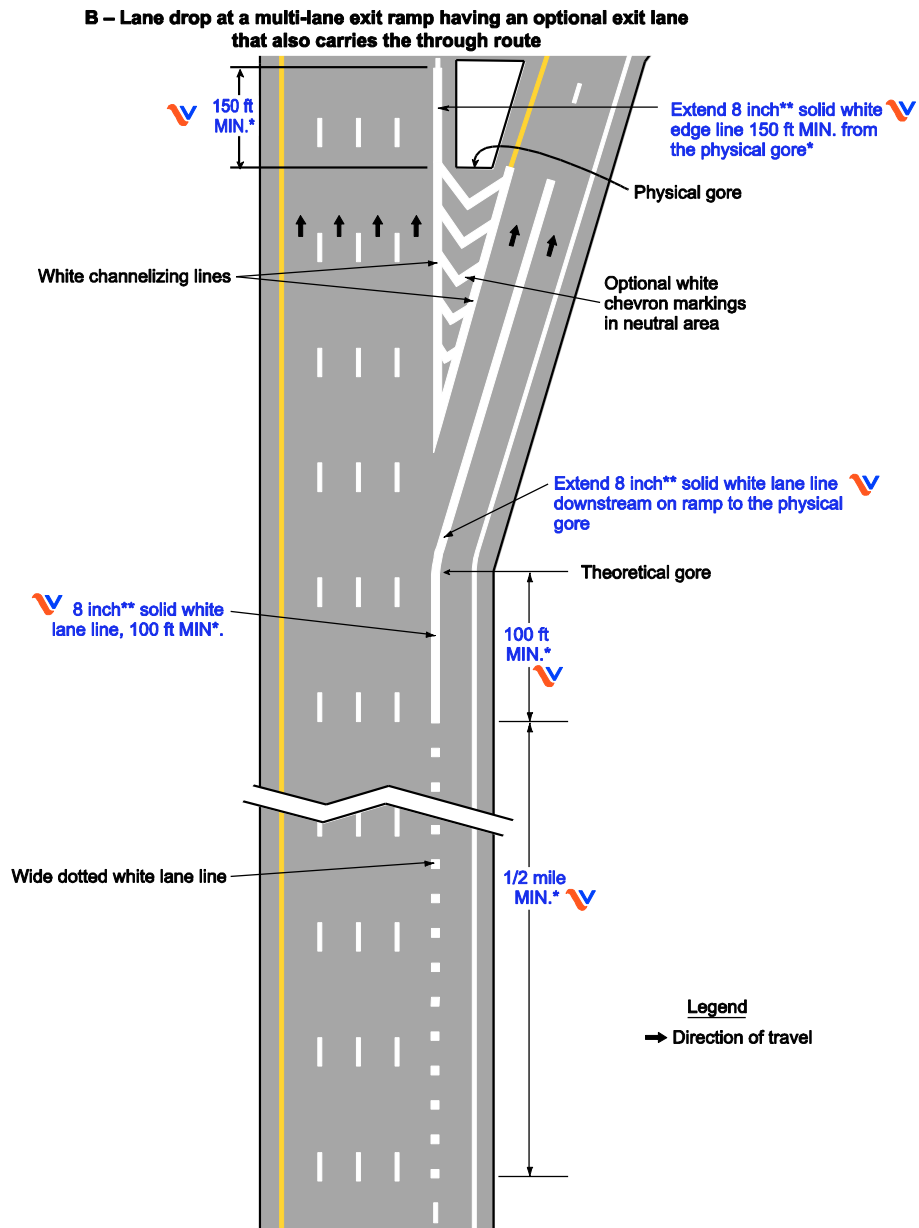
**Figure 3B-10(VA). Examples of Applications of Freeway and Expressway Lane-Drop Markings (Sheet 1 of 5)**



\*Minimums are recommended distances where spacing allows or is feasible

\*\*For all thicker emphasis lines in gore and lane drop areas, the width shall be 8 inches minimum.

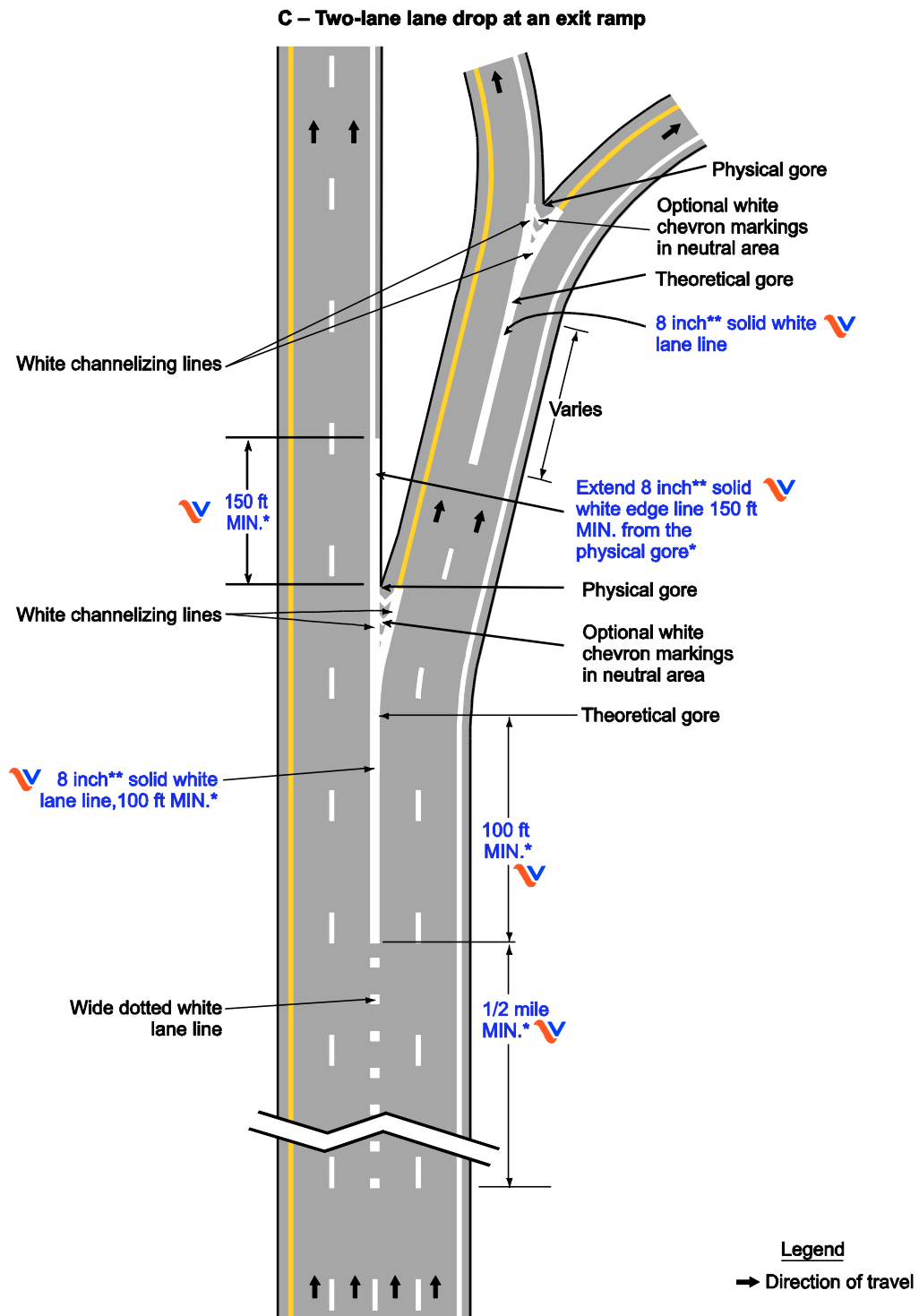
## Figure 3B-10(VA). Examples of Applications of Freeway and Expressway Lane-Drop Markings (Sheet 2 of 5)



\*Minimums are recommended distances where spacing allows or is feasible

\*\*For all thicker emphasis lines in gore and lane drop areas, the width shall be 8 inches minimum.

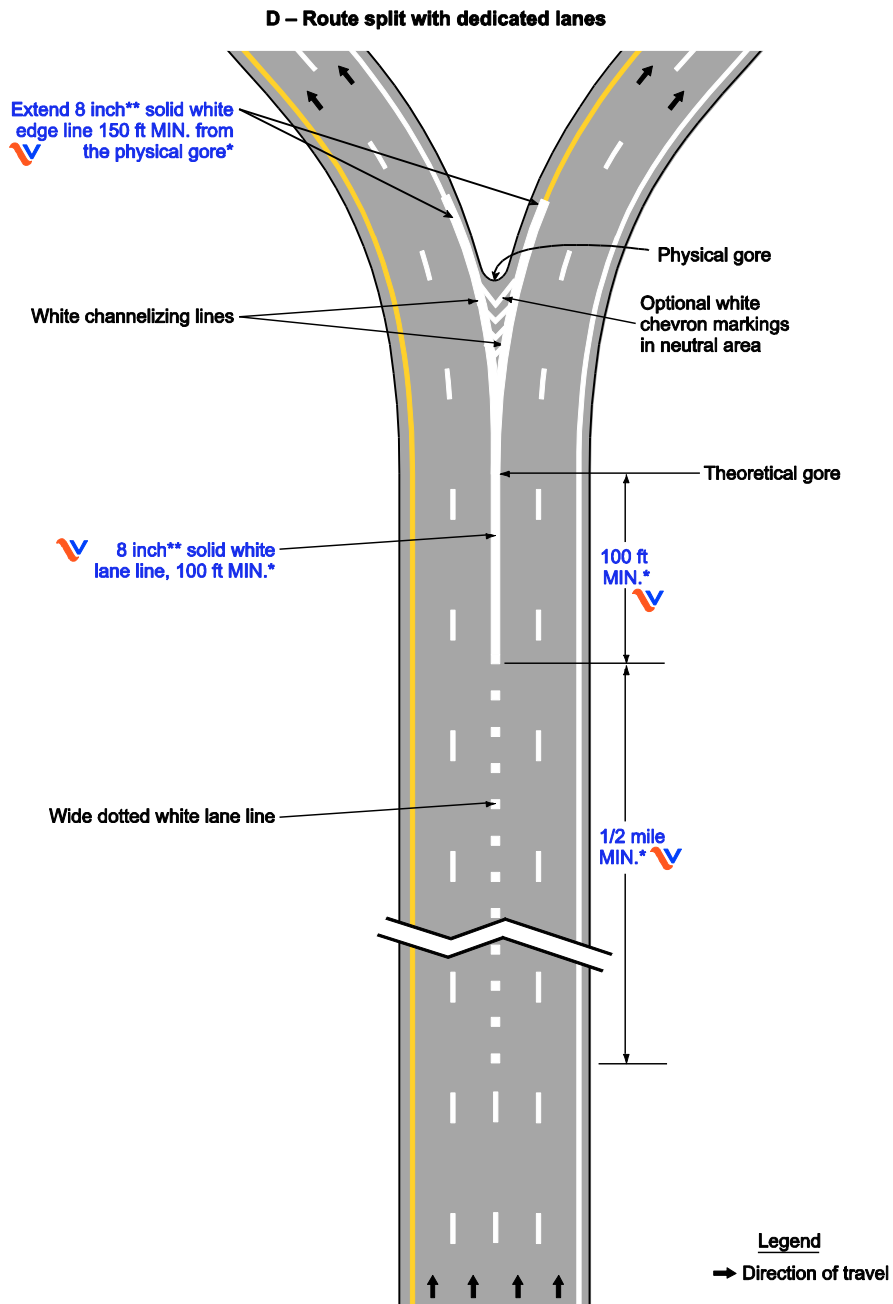
**Figure 3B-10(VA). Examples of Applications of Freeway and Expressway Lane-Drop Markings (Sheet 3 of 5)**



\*Minimums are recommended distances where spacing allows or is feasible

\*\*For all thicker emphasis lines in gore and lane drop areas, the width shall be 8 inches minimum.

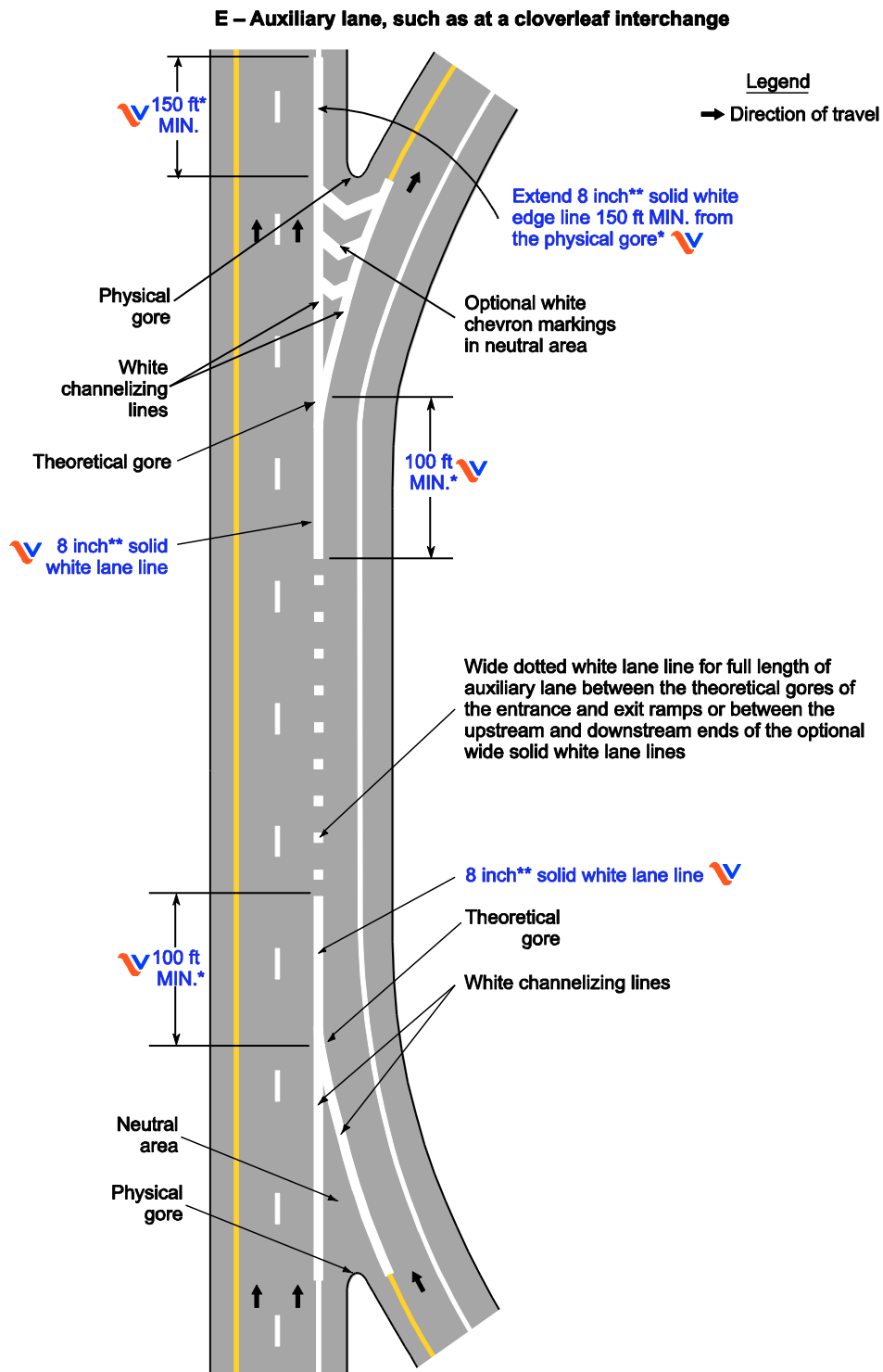
### Figure 3B-10(VA). Examples of Applications of Freeway and Expressway Lane-Drop Markings (Sheet 4 of 5)



\*Minimums are recommended distances where spacing allows or is feasible

\*\*For all thicker emphasis lines in gore and lane drop areas, the width shall be 8 inches minimum.

### Figure 3B-10(VA). Examples of Applications of Freeway and Expressway Lane-Drop Markings (Sheet 5 of 5)



\*Minimums are recommended distances where spacing allows or is feasible

\*\*For all thicker emphasis lines in gore and lane drop areas, the width shall be 8 inches minimum.

**Option:**

- 15 The length of the 8-inch minimum solid white lane line may be greater than 100 feet based on engineering judgment.

**Standard:**

- 16 **A wide dotted white lane line shall be used:**
- A. As a lane drop marking in advance of lane drops at exit ramps to distinguish a lane drop from a normal exit ramp (see Drawings A, B, and C of Figure 3B-10(VA) in this Supplement),
  - B. In advance of freeway route splits with dedicated lanes (see Drawing D of Figure 3B-10(VA) in this Supplement),
  - C. To separate a through lane that continues beyond an interchange from an adjacent auxiliary lane between an entrance ramp and an exit ramp, (see Drawing E of Figure 3B-10(VA) in this Supplement),
  - D. As a lane drop marking in advance of lane drops at intersections to distinguish a lane drop from an intersection through lane (see Drawing A of Figure 3B-11(VA) in this Supplement), and
  - E. To separate a through lane that continues beyond an intersection from an adjacent auxiliary lane between two intersections (see Drawing B of Figure 3B-11(VA) in this Supplement).

**Guidance:**

- 17 *On the approach to a multi-lane exit ramp having an optional exit lane that also carries through traffic, lane line markings should be used as illustrated in Drawing B of Figure 3B-10(VA) in this Supplement. In this case, if the right-most exit lane is an added lane such as a parallel deceleration lane, the lane drop marking should begin at the upstream end of the full-width deceleration lane, as shown in Drawing C of Figure 3B-8(VA) in this Supplement.*
- 18 *Lane drop markings used in advance of lane drops at freeway and expressway exit ramps should begin at least 1/2 mile in advance of the 8-inch minimum solid white lane line.*
- 19 *The dotted white lane lines that are used for lane drop markings and that are used as a lane line separating through lanes from auxiliary lanes should consist of line segments that are 3 feet in length separated by 9-foot gaps.*

**Standard:**

- 20 **On the approach to a multi-lane exit ramp having a lane drop condition and an optional exit lane that also carries through traffic, an 8-inch minimum white lane line marking shall be used to separate the drop lane from the optional exit lane.**
- 21 **On the approach to a multi-lane exit ramp having an additional tapered parallel deceleration lane and an optional exit lane that also carries through traffic, an 8-inch minimum white lane line marking shall be used to separate the tapered parallel deceleration lane from the optional exit lane.**



*Guidance:*

- 22 *On the approach to a multi-lane exit ramp having a lane drop condition and an optional exit lane that also carries through traffic, the 8-inch minimum white line should extend from 100 feet in advance of the theoretical gore to the physical gore (see Drawing B of Figure 3B-10(VA) in this Supplement). On the approach to a multi-lane exit ramp having an additional tapered parallel deceleration lane and an optional exit lane that also carries through traffic, the 8-inch minimum white line should extend from 100 feet in advance of the theoretical gore to the physical gore (see Drawing C of Figure 3B-8(VA) in this Supplement).*
- 23 *Lane drop markings used in advance of lane drops at intersections should begin a distance in advance of the intersection that is determined by engineering judgment as suitable to enable drivers who do not desire to make the mandatory turn to move out of the lane being dropped prior to reaching the queue of vehicles that are waiting to make the turn. The lane drop marking should begin no closer to the intersection than the most upstream regulatory or warning sign associated with the lane drop.*

**Support:**

- 24 **Section 3B.20 of this Supplement** contains information regarding other markings that are associated with lane drops, such as lane-use arrow markings and ONLY word markings.
- 25 **Section 3B.09 of this Supplement** contains information about the lane line markings that are to be used for transition areas where the number of through lanes is reduced.

**Standard:**

- 26 **Where crossing the lane line markings is discouraged, the lane line markings shall consist of a normal or wide solid white line.**

*Guidance:*

- 27 *At an intersection, a normal width solid white lane line should extend at least 100 feet upstream from the stop line.*

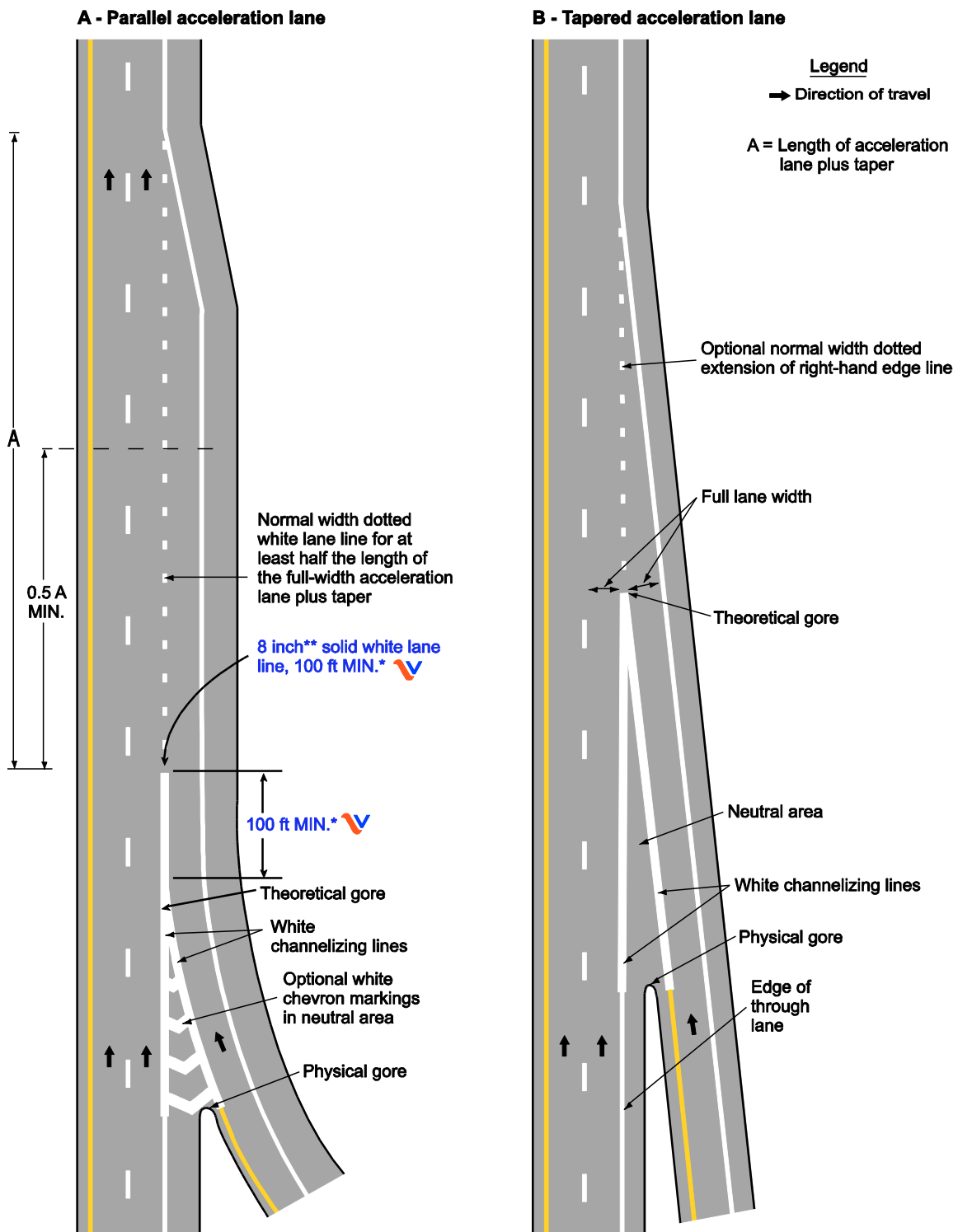
**Support:**

- 28 **Section 3B.09 of this Supplement** contains information about the lane line markings that are to be used for transition areas where the number of through lanes is reduced.





### Figure 3B-9(VA) Example of Dotted Line and Channelizing Line Applications for Entrance Ramp Markings

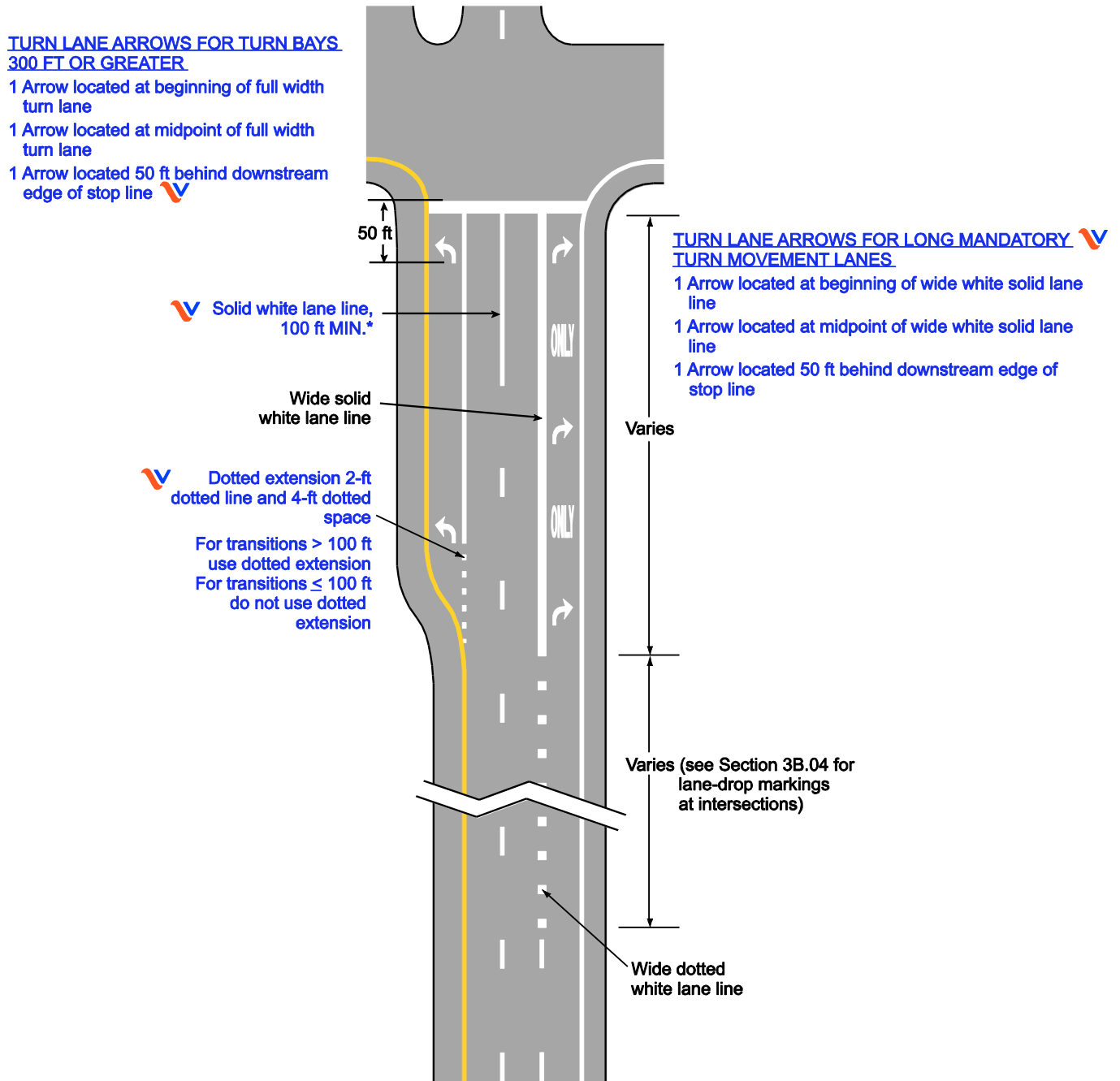


\*Minimums are recommended distances where spacing allows or is feasible

\*\*For all thicker emphasis lines in gore areas, the width shall be 8 inches minimum.

## Figure 3B-11(VA). Examples of Applications of Intersection Approach Markings (Sheet 1 of 2)

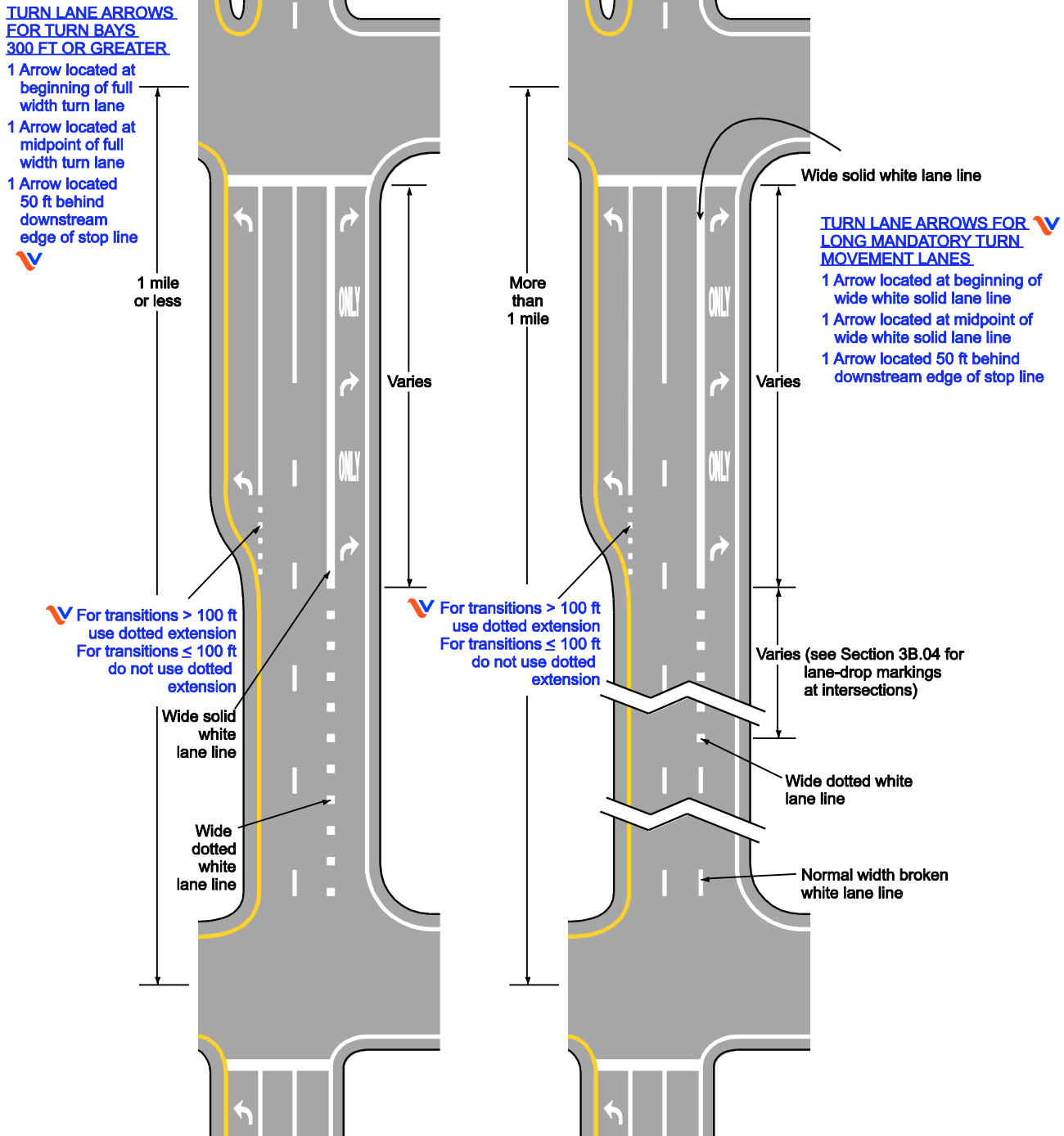
**A – Lane drop at an intersection**




\* Minimums are recommended distances where spacing allows or is feasible

### Figure 3B-11(VA). Examples of Applications of Intersection Approach Markings (Sheet 2 of 2)

#### B – Auxiliary lane between intersections



*Guidance:*

- 
- 29 *On approaches to intersections, a solid white lane line marking should be used to separate a through lane from an added mandatory turn lane.*
- 30 *On tapers approaching added mandatory turn lanes, dotted white lane line markings with a 2-foot line and 4-foot space should be used. If the added mandatory turn lane is less than or equal to 100 feet in length, dotted white lane line markings should not be used (see Figure 3B-11(VA) in this Supplement).*

*Option:*


- 31 Where the median width allows the left-turn lanes to be separated from the through lanes to give drivers on opposing approaches a less obstructed view of opposing through traffic, white pavement markings may be used to form channelizing islands as shown in Figure 2B-17 in the MUTCD.
- 32 Solid white lane line markings may be used to separate through traffic lanes from auxiliary lanes, such as an added uphill truck lane or a preferential lane (see Section 3D.02 of this Supplement).
- 33 Wide solid lane line markings may be used for greater emphasis.

**Standard:**

- 34 **Where crossing the lane line markings is prohibited, the lane line markings shall consist of a solid double white line (see Figure 3B-12).**

## **Section 3B.05 Other White Longitudinal Pavement Markings**

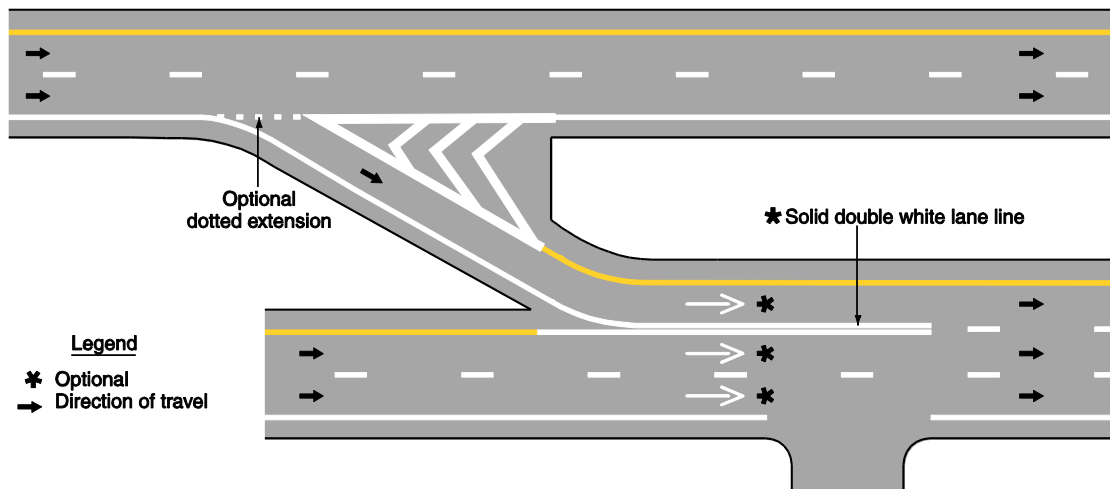
**Standard:**

- 
- 01 **A channelizing line shall be a wide or double solid white line.**
- 02 **Channelizing lines shall be used to form channelizing islands where traffic traveling in the same direction is permitted on both sides of the island.**
- 03 **Other pavement markings in the channelizing island area shall be white.**

*Support:*

- 04 Examples of channelizing line applications are shown in Figures 3B-8(VA), 3B-9(VA), and 3B-10(VA) in this Supplement, and in Drawing C of Figure 3B-15.
- 05 Channelizing lines at exit ramps as shown in Figures 3B-8(VA) and 3B-10(VA) in this Supplement define the neutral area, direct exiting traffic at the proper angle for smooth divergence from the main lanes into the ramp, and reduce the probability of colliding with objects adjacent to the roadway.

**Figure 3B-12. Example of Solid Double White Lines Used to Prohibit Lane Changing**



- 06 Channelizing lines at entrance ramps as shown in Figures 3B-9(VA) and 3B-10(VA) in this Supplement promote orderly and efficient merging with the through traffic.

**Standard:**

- 07 For all exit ramps and for entrance ramps with parallel acceleration lanes, channelizing lines shall be placed on both sides of the neutral area (see Figures 3B-8(VA) and 3B-10(VA) and Drawing A of Figure 3B-9(VA) in this Supplement).

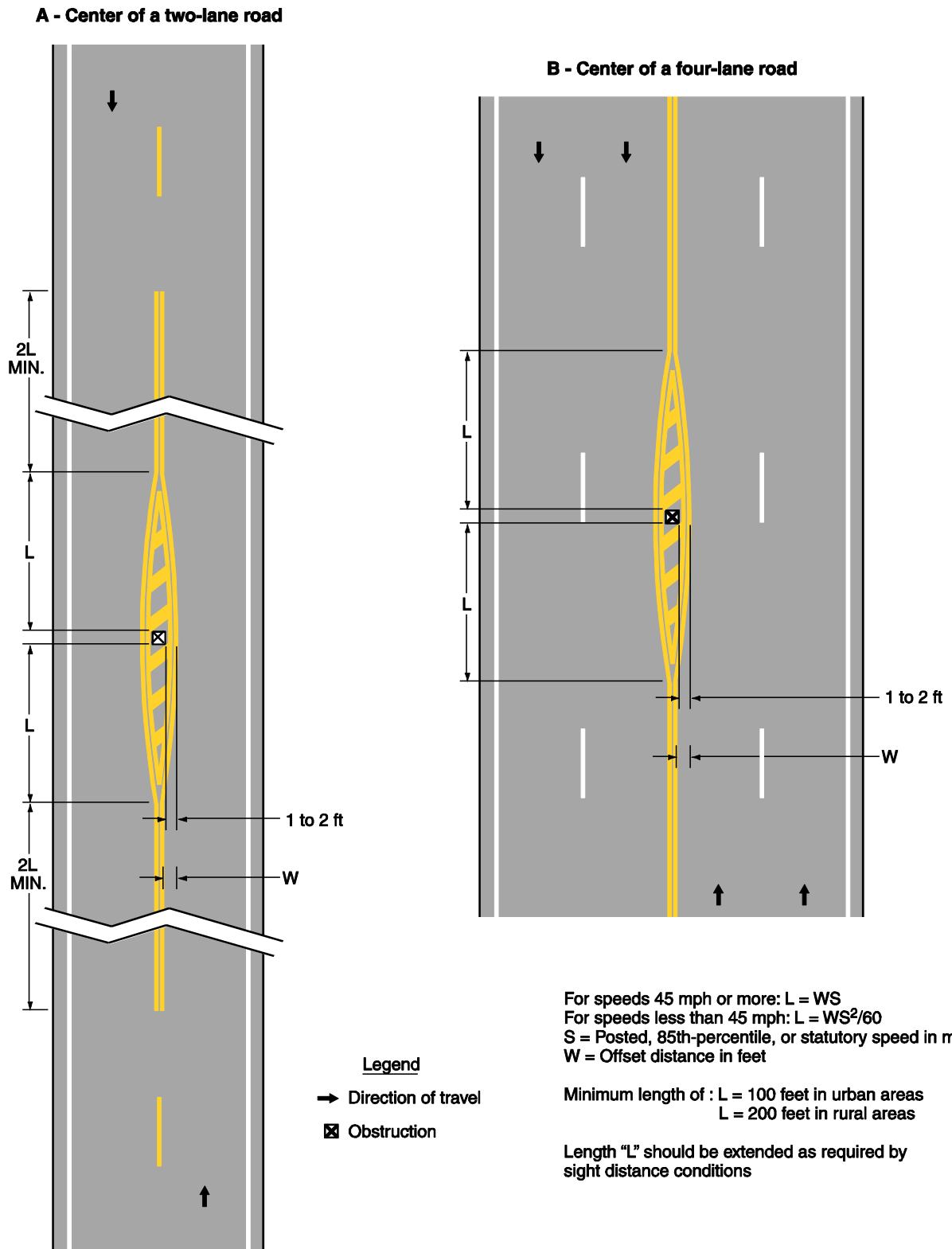


- ~~08 For entrance ramps with tapered acceleration lanes, channelizing lines shall be placed along both sides of the neutral area to a point at least one half of the distance to the theoretical gore (see Drawing C of Figure 3B-9(VA)).~~

**Standard:**

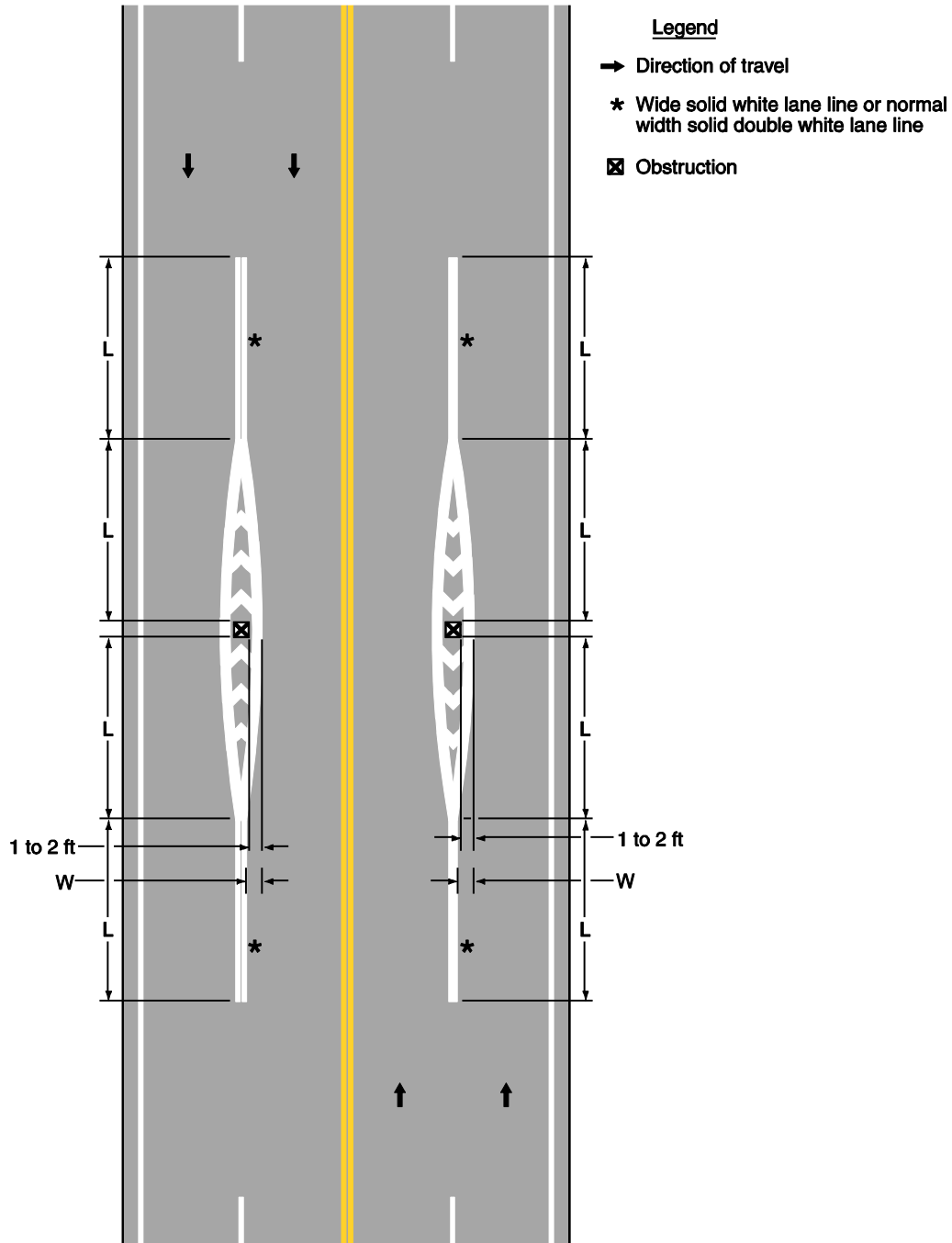
- 09 For entrance ramps with tapered acceleration lanes, the channelizing lines shall extend to the theoretical gore (see Drawing B of Figure 3B-9(VA) in this Supplement).

### Figure 3B-15. Examples of Applications of Markings for Obstructions in Roadway (Sheet 1 of 2)



## Figure 3B-15. Examples of Applications of Markings for Obstructions in Roadway (Sheet 2 of 2)

**C - Traffic passing in the same direction on both sides of an obstruction**



For speeds of 45 mph or more:  $L = WS$   
 For speeds of less than 45 mph:  $L = WS^2/60$   
 S = Posted, 85th-percentile, or statutory speed in mph  
 W = Offset distance in feet

Minimum length of: L = 100 feet in urban areas  
 L = 200 feet in rural areas

Length "L" should be extended as required by sight distance conditions

Option:

- 10 White chevron crosshatch markings (see [Section 3B.24 of this Supplement](#)) may be placed in the neutral area of exit ramp and entrance ramp gores for special emphasis as shown in [Figures 3B-8\(VA\) and 3B-10\(VA\)](#) and Drawing A of [Figure 3B-9\(VA\)](#) in this [Supplement](#). The channelizing lines and the optional chevron crosshatch markings at exit ramp and entrance ramp gores may be supplemented with white retroreflective or internally illuminated raised pavement markers (see [Sections 3B.11 and 3B.13 of this Supplement](#)) for enhanced nighttime visibility.

**Standard:**

- 11 **For gore areas, 8-inch minimum solid white lines shall be used for channelizing lines from the beginning of the theoretical gore to the beginning of the physical gore.**



## **Section 3B.06 Edge Line Pavement Markings**

**Standard:**

- 01 **If used, edge line pavement markings shall delineate the right or left edges of a roadway.**
- 02 **Except for dotted edge line extensions (see [Section 3B.08 of this Supplement](#)), edge line markings shall not be continued through intersections or major driveways.**
- 03 **If used on the roadways of divided highways or one-way streets, or on any ramp in the direction of travel, left edge line pavement markings shall consist of a normal solid yellow line to delineate the left-hand edge of a roadway or to indicate driving or passing restrictions left of these markings.**
- 04 **If used, right edge line pavement markings shall consist of a normal solid white line to delineate the right-hand edge of the roadway.**

*Guidance:*

- 05 *Edge line markings should not be broken for minor driveways.*

**Support:**

- 06 Edge line markings have unique value as visual references to guide road users during adverse weather and visibility conditions.

Option:

- 07 Wide solid edge line markings may be used for greater emphasis.

**Standard:**

- 08 **Where a paved shoulder is provided, the edge line, if used, shall be placed in the travel lane and not in the paved shoulder area.**





## Section 3B.07 Warrants for Use of Edge Lines

### Standard:



- ~~01 Edge line markings shall be placed on paved streets or highways with the following characteristics:~~
- ~~A. Freeways,~~
  - ~~B. Expressways, and~~
  - ~~C. Rural arterials with a traveled way of 20 feet or more in width and an ADT of 6,000 vehicles per day or greater.~~

### Guidance:

- 02 *Edge line markings should be placed on paved streets or highways with the following characteristics:*
- A. *Rural arterials and collectors with a traveled way of 20 feet or more in width and an ADT of 3,000 vehicles per day or greater.*
  - B. *At other paved streets and highways where an engineering study indicates a need for edge line markings.*
- 03 *Edge line markings should not be placed where an engineering study or engineering judgment indicates that providing them is likely to decrease safety.*

### Option:

- 04 Edge line markings may be placed on streets and highways with or without center line markings.
- 05 Edge line markings may be excluded, based on engineering judgment, for reasons such as if the traveled way edges are delineated by curbs, parking, or other markings.
- 06 If a bicycle lane is marked on the outside portion of the traveled way, the edge line that would mark the outside edge of the bicycle lane may be omitted.
- 07 Edge line markings may be used where edge delineation is desirable to minimize unnecessary driving on paved shoulders or on refuge areas that have lesser structural pavement strength than the adjacent roadway.

### Standard:



- 08 **Except as provided in Paragraph 10 below, edge line markings shall be placed on roadways meeting any of the following criteria:**
- A. Two-lane paved highways without curb and gutter having a pavement width of 20 feet or greater and center line pavement markings;**
  - B. Sections of Primary routes subject to frequent fog or located on mountain crossings;**
  - C. At narrow structures on all Primary routes where the horizontal clearance between the structure and edge of the pavement is 3 feet or less;**
- 09 **On two-lane roadways without continuous edge lines, edge lines shall be installed on approach to single-lane structures. In each direction, edge lines shall be installed in**

the transition section and 300 feet upstream of the transition section (see Figure 3B-V1 in this Supplement).

*Guidance*

- 10 *Edge line markings should not be installed on subdivision streets, unless the street is primarily serving through traffic.*

*Support:*

- 11 Criteria for placement of edge line markings are shown in Table 3B-V2.



**Table 3B-V2. Criteria For Placement of Edge Line Markings**

Pavement Width	Traffic Volume	Roadway Type					
		Undivided Limited Access	Bi-directional multi-lane	Two-lane Paved Roads with Center Line & without Curb and Gutter	Other Rural Arterials and Collectors	Local Residential	All Other Paved Roadway Segments
≥ 20 feet	≥ 3,000 vpd	Required	Required	Required	Recommended	Not Recommended unless primarily serving through traffic	May be considered only where Engineering Study indicates a need
	< 3,000 vpd	Required	Required	Required	May be considered only where Engineering Study indicates a need		
< 20 feet	≥ 3,000 vpd	Required	Required	May be considered only where Engineering Study indicates a need			
	< 3,000 vpd	Required	Required				

Note: See Paragraphs 8 and 9 of Section 3B.07 in this Supplement for additional locations where edge lines are required.

## **Section 3B.08 Extensions through Intersections or Interchanges**

**Standard:**

- 01 **Except as provided in Paragraph 2, pavement markings extended into or continued through an intersection or interchange area shall be the same color and at least the same width as the line markings they extend (see Figure 3B-13(VA) in this Supplement).**

**Option:**

- 02 A normal line may be used to extend a wide line through an intersection.

**Standard:**

- 03 **Where highway design or reduced visibility conditions make it desirable to provide control or to guide vehicles through an intersection or interchange, such as at offset, skewed, complex, or multi-legged intersections, on curved roadways, where multiple**



**turn lanes are used, or where offset turn lanes might cause driver confusion, dotted line extension markings consisting of 2-foot line segments and 4-foot gaps shall be used to extend longitudinal line markings through an intersection or interchange area.**

Option:

- 04 Dotted edge line extensions may be placed through intersections or major driveways.

*Guidance:*

- 05 *Where greater restriction is required, solid lane lines or channelizing lines should be extended into or continued through intersections or major driveways.*

**Standard:**

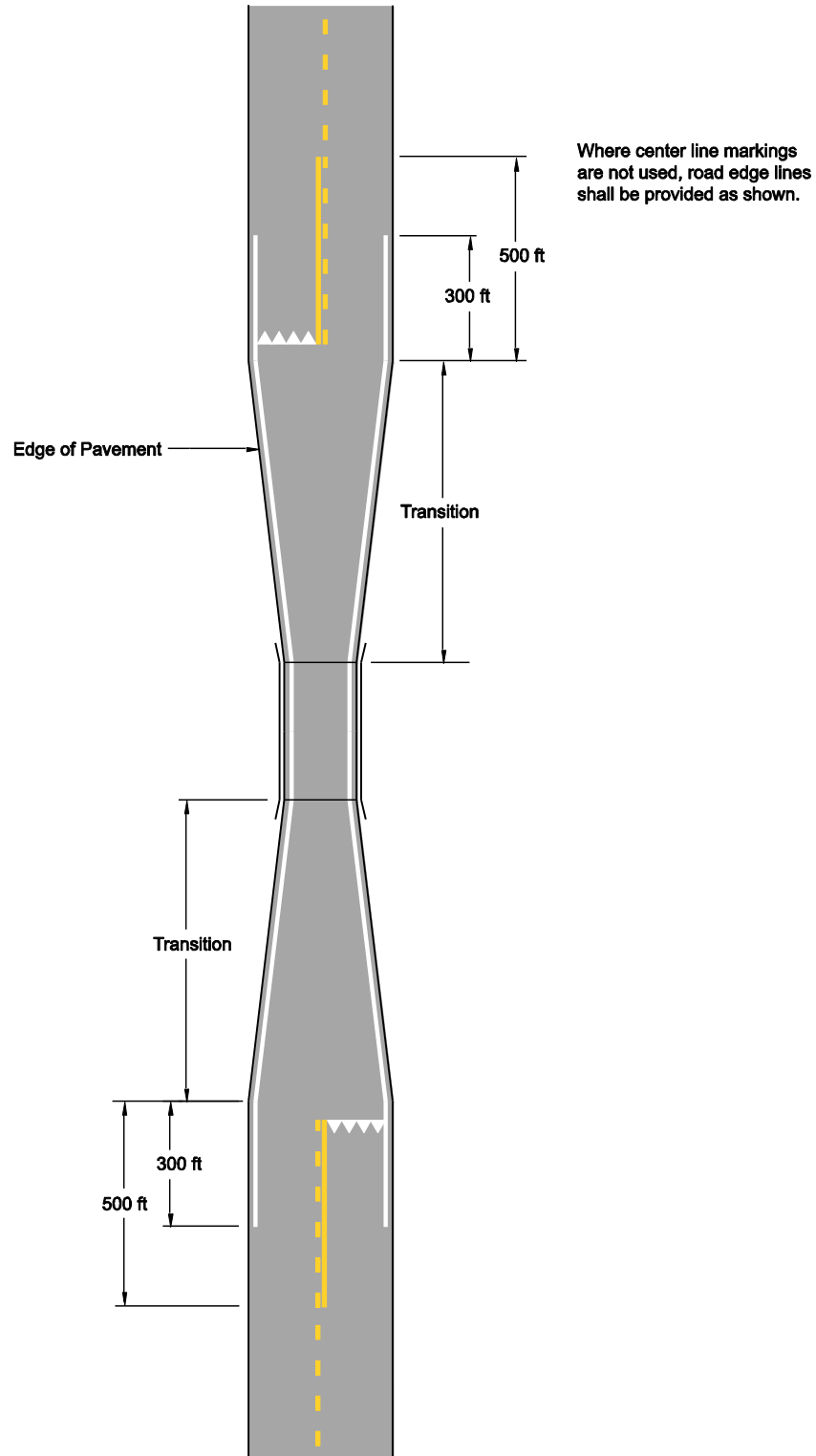
- 06 **Solid lines shall not be used to extend edge lines into or through intersections or major driveways.**

*Guidance:*

- 07 *Where a double line is extended through an intersection, a single line of equal width to one of the lines of the double line should be used.*
- 08 *To the extent possible, pavement marking extensions through intersections should be designed in a manner that minimizes potential confusion for drivers in adjacent or opposing lanes.*



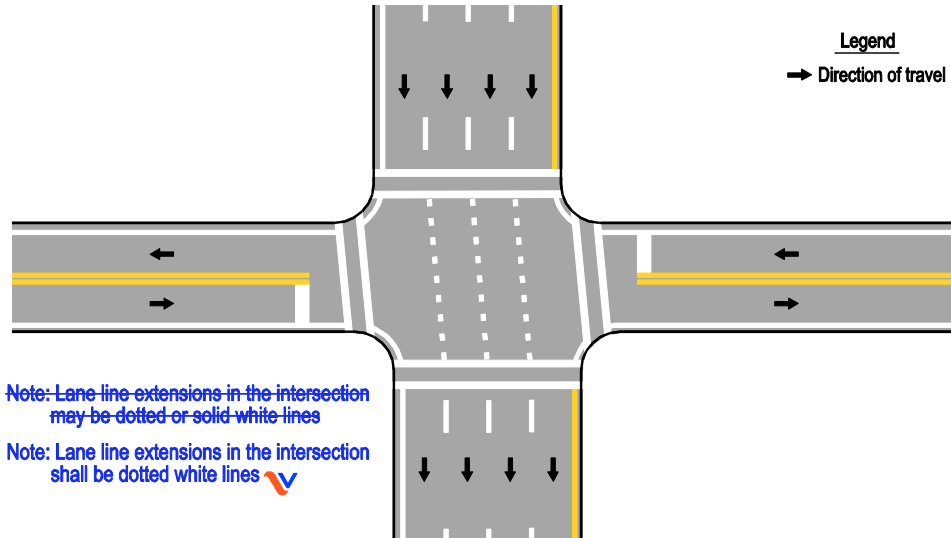
### Figure 3B-V1. Typical Markings for Single Lane Structures on Two-Lane Roadways without Continuous Road Edge Lines



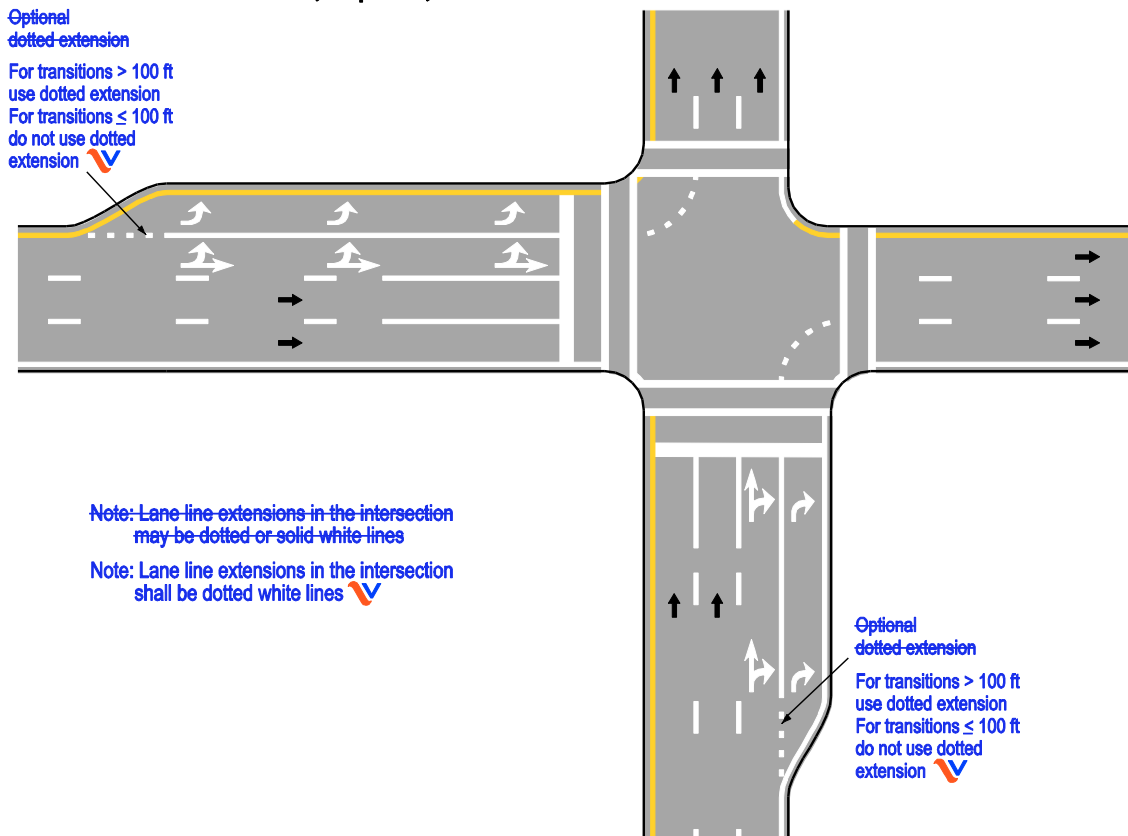
NOTE: See Figure 2C-V1 for typical sign placement for single lane structures on two-lane roadways.

## Figure 3B-13(VA). Examples of Line Extensions through Intersections (Sheet 1 of 2)

**A - Typical pavement markings with offset lane lines continued through the intersection and optional crosswalk lines and stop lines**

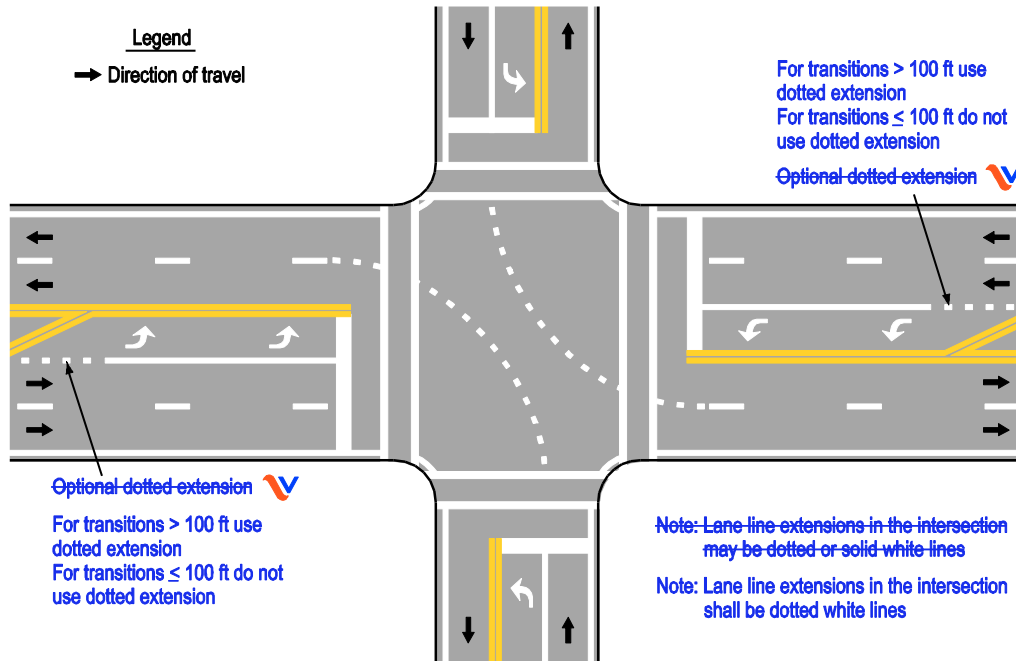


**B - Typical pavement markings with double-turn lanes, lane-use turn arrows, and optional crosswalk lines, stop lines, and line extensions into intersection for double turns**

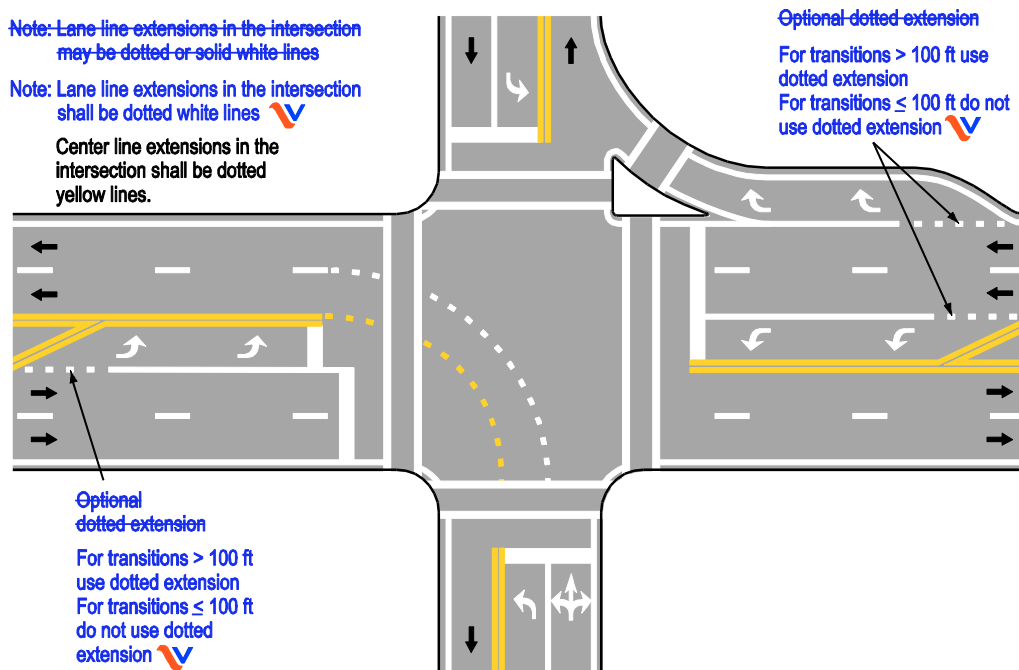


## Figure 3B-13(VA). Examples of Line Extensions through Intersections (Sheet 2 of 2)

### C - Typical dotted line markings to extend lane line markings into the intersection



### D - Typical dotted line markings to extend center line and lane line markings into the intersection



## Section 3B.09 Lane-Reduction Transition Markings

### Support:

- 01 Lane-reduction transition markings are used where the number of through lanes is reduced because of narrowing of the roadway or because of a section of on-street parking in what would otherwise be a through lane. Lane-reduction transition markings are not used for lane drops.

### Standard:

- 02 **Except as provided in Paragraph 3, where pavement markings are used, lane-reduction transition markings shall be used to guide traffic through transition areas where the number of through lanes is reduced, as shown in Figure 3B-14. On two-way roadways, no-passing zone markings shall be used to prohibit passing in the direction of the convergence, and shall continue through the transition area.**

### Option:

- 03 On low-speed urban roadways where curbs clearly define the roadway edge in the lane-reduction transition, or where a through lane becomes a parking lane, the edge line and/or delineators shown in Figure 3B-14 may be omitted as determined by engineering judgment.

### Guidance:

- 04 *For roadways having a posted or statutory speed limit of 45 mph or greater, the transition taper length for a lane-reduction transition should be computed by the formula  $L = WS$ . For roadways where the posted or statutory speed limit is less than 45 mph, the formula  $L = WS^2/60$  should be used to compute the taper length.*

### Support:

- 05 Under both formulas, L equals the taper length in feet, W equals the width of the offset distance in feet, and S equals the 85th-percentile speed or the posted or statutory speed limit, whichever is higher.

### Guidance:

- 06 *Where observed speeds exceed posted or statutory speed limits, longer tapers should be used.*

### Option:

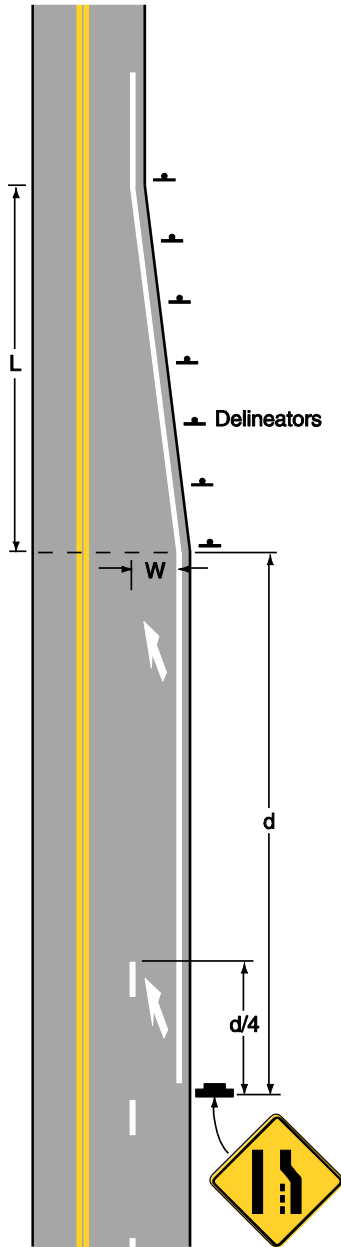
- 07 On new construction, where no posted or statutory speed limit has been established, the design speed may be used in the transition taper length formula.

### Guidance:

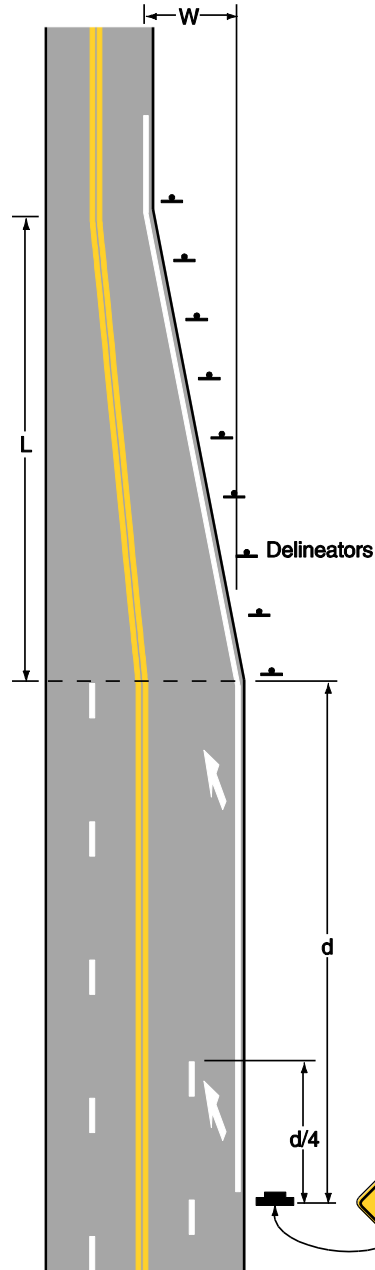
- 08 *Lane line markings should be discontinued one-quarter of the distance between the Lane Ends sign (see [Section 2C.42 in the MUTCD](#)) and the point where the transition taper begins.*
- 09 *Except as provided in Paragraph 3 for low-speed urban roadways, the edge line markings shown in Figure 3B-14 should be installed from the location of the Lane Ends warning sign to beyond the beginning of the narrower roadway.*

### Figure 3B-14. Examples of Applications of Lane-Reduction Transition Markings

**A – Lane reduction**



**B – Lane reduction with lateral shift to the left**



Notes:

1. Lane-reduction arrows are optional for speeds of less than 45 mph
2. See Section 3F.04 for delineator spacing
3.  $L = WS$  for speeds of 45 mph or greater and  $L = WS^2/60$  for speeds of less than 45 mph, where:  
 $L$  = Length of taper in feet  
 $S$  = Posted, 85th-percentile, or statutory speed in mph  
 $W$  = Offset in feet
4.  $d$  = Advance warning distance (see Section 2C.05)

Support:

10 Pavement markings at lane-reduction transitions supplement the standard signs.



**Standard:**

- 11 **Where a lane-reduction transition occurs on a roadway with a speed limit of 45 mph or greater, the lane-reduction arrow markings shall be used (see Figure 3B-14 and Drawing F in Figure 3B-24(VA)).**

*Guidance:*

- 12 *Except for acceleration lanes, where a lane-reduction transition occurs on a roadway with a speed limit of less than 45 mph, the lane-reduction arrow markings shown in Drawing F in Figure 3B-24(VA) in this Supplement should be used if determined to be appropriate based on engineering judgment.*

## **Section 3B.11 Raised Pavement Markers – General**

**Standard:**

- 01 **Permanent raised pavement markers used for the purpose of delineation shall be snowplowable, unless otherwise approved to address unique or temporary situations. For use of temporary markers see the “Virginia Work Area Protection Manual.”**
- 02 **The color of raised pavement markers under both daylight and nighttime conditions shall conform to the color of the marking for which they serve as a positioning guide, or for which they supplement or substitute.**

*Option:*

- 03 The side of a raised pavement marker that is visible to traffic proceeding in the wrong direction may be red (see [Section 3A.05 of this Supplement](#)).
- 04 Retroreflective or internally illuminated raised pavement markers may be used in the roadway immediately adjacent to curbed approach ends of raised medians and curbs of islands, or on top of such curbs (see [Section 3B.23 of the MUTCD](#)).

*Support:*

- 05 Retroreflective and internally illuminated raised pavement markers are available in mono-directional and bidirectional configurations. The bidirectional marker is capable of displaying the applicable color for each direction of travel.
- 06 Blue raised pavement markers are sometimes used in the roadway to help emergency personnel locate fire hydrants.

**Standard:**

- 07 **When used, internally illuminated raised pavement markers shall be steadily illuminated and shall not be flashed.**

*Support:*

- 08 Flashing raised pavement markers are considered to be In-Roadway Lights (see Chapter 4N).

*Guidance:*

- 09 *Non-retroreflective raised pavement markers should not be used alone, without supplemental retroreflective or internally illuminated markers, as a substitute for other types of pavement markings.*

- 10 *Directional configurations should be used to maximize correct information and to minimize confusing information provided to the road user. Directional configurations also should be used to avoid confusion resulting from visibility of markers that do not apply to the road user.*
- 11 *The spacing of raised pavement markers used to supplement or substitute for other types of longitudinal markings should correspond with the pattern of broken lines for which the markers supplement or substitute.*

**Standard:**

- 12 **The value of N cited in Sections 3B.12 through 3B.14 of this Supplement for the spacing of raised pavement markers shall equal the length of one line segment plus one gap of the broken lines used on the highway.**

**Option:**

- 13 For additional emphasis, retroreflective raised pavement markers may be spaced closer than described in Sections 3B.12 through 3B.14 of this Supplement, as determined by engineering judgment or engineering study.

**Support:**

- 14 Figures 9-20 through 9-22 in the "Traffic Control Devices Handbook" (see Section 1A.11 in this Supplement) contain additional information regarding the spacing of raised pavement markers on longitudinal markings.

**Standard:**

- 15 **Raised pavement markers shall be installed on roadways meeting the conditions shown in Table 3B-V3 in this Supplement.**

**Guidance:**

- 16 *Raised pavement markers should be considered for installation on roadways meeting the conditions shown in Table 3B-V4 in this Supplement.*

**Option:**

- 17 Raised pavement markers may be considered for installation on roadways meeting the conditions shown in Table 3B-V5 in this Supplement.

**Support:**

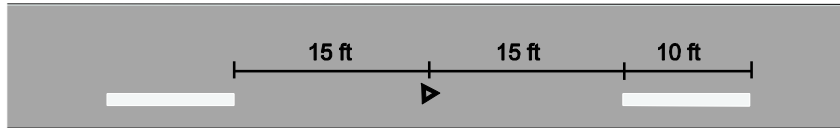
- 18 Figure 3B-V2 in this Supplement provides typical spacing layouts of raised pavement markers.



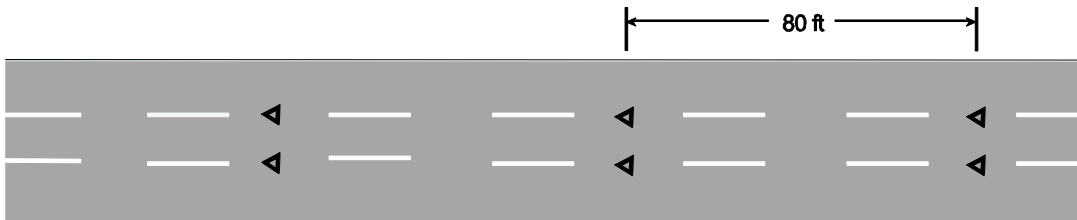


## Figure 3B-V2. Typical Raised Pavement Marker Layout Details (Sheet 1 of 2)

### A - Raised Pavement Markers supplementing broken lines



### B - Divided roadways

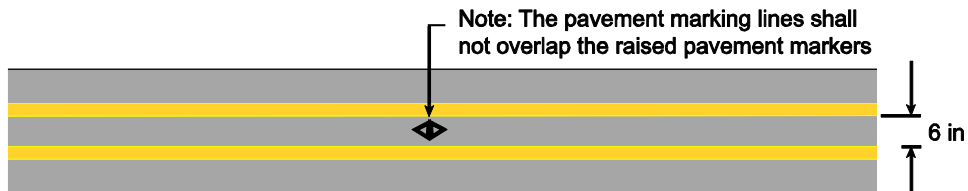


Note: Raised Pavement Marker spacing may be reduced along curves or in other locations based on engineering judgement.

### C - Raised Pavement Markers adjacent to solid line



### D - Raised Pavement Markers between double solid lines



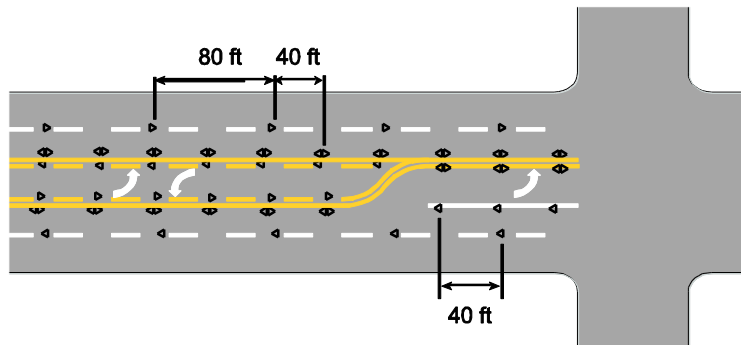
#### Key

- ◊ Two-way, with points facing each direction of traffic
- ◄ One-way, with point facing traffic



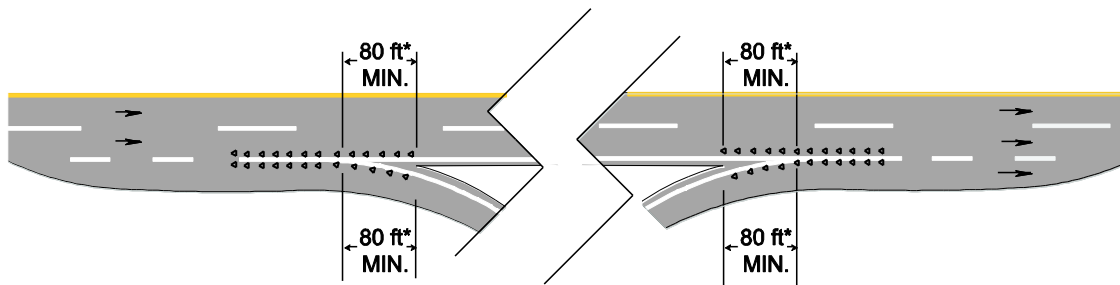
## Figure 3B-V2. Typical Raised Pavement Marker Layout Details (Sheet 2 of 2)

**E - Two-way left turn lane and center lane left turn**



Note: Raised Pavement Marker spacing may be modified based on engineering judgement.

**F - Exit and entrance ramps**



**Key**

- ◄ Two-way, with points facing each direction of traffic
- ◄ One-way, with point facing traffic

\* Raised Pavement Markers may be extended along the entire channelizing line if needed for additional delineation, visibility, or emphasis.



**Table 3B-V3. Conditions where Snowplowable Raised Pavement Markers (SRPMs) Shall be Installed**

Facility Type / Conditions	Required Placement
Limited Access Highways $\geq$ 2 miles in length AND Posted Speed Limit $\geq$ 55 MPH	SRPMs shall be installed continuously and to supplement solid lines at exit and entrance ramps at gore areas.
Limited Access Highways < 2 miles in length AND With posted Speed Limit $\geq$ 55 MPH AND Where adjacent approaching or departing non-limited access sections are marked with SRPMs	SRPMs shall be installed continuously and to supplement solid lines at exit and entrance ramps at gore areas.
Roadway Facilities with Posted Speed Limit $\geq$ 60 MPH	SRPMs shall be installed continuously.
Two-Lane, Two-Way Roadways with: AADT $\geq$ 15,000 AND No roadway lighting	SRPMs shall be installed continuously.
Multilane Roadways with: AADT $\geq$ 25,000 AND Posted Speed Limit $\geq$ 45 MPH AND No roadway lighting	SRPMs shall be installed continuously.



**Table 3B-V4. Conditions where Snowplowable Raised Pavement Markers (SRPMs) Should be Considered**

Facility Type/Conditions	Recommended Placement	Additional Considerations
Multilane Roadways with: 15,000 $\leq$ AADT < 25,000 AND Posted Speed Limit 45-55 mph	SRPMs should be installed continuously.	If roadway lighting is present, engineering judgment should be used to determine if SRPMs will add benefit to the motorists.



**Table 3B-V5. Conditions where Snowplowable Raised Pavement Markers (SRPMs) May be Considered**

Facility Type/Conditions	Placement	Additional Considerations
<b>Two-Lane, Two-Way Roadways with:</b> <b>5,000 ≤ AADT &lt; 15,000</b> <b>AND</b> <b>Only if the sections DO NOT have multiple horizontal curves with Posted Speed Limit &lt; 55 MPH</b>	SRPMs may be installed continuously.	Engineering judgment should be applied to determine whether SRPMs will add benefit to the motorists. Engineering judgment should take into consideration the presence of roadway lighting.
<b>Two-Lane, Two-Way Roadways with:</b> <b>AADT ≥ 15,000</b> <b>AND</b> <b>Roadway lighting present</b>	SRPMs may be installed continuously.	Engineering judgment should be used to determine if SRPMs will add benefit to the motorists.
<b>Multilane Roadways with:</b> <b>AADT ≥ 25,000</b> <b>AND</b> <b>Posted Speed Limit 45-55 mph</b> <b>AND</b> <b>Roadway lighting present</b>	SRPMs may be installed continuously.	Engineering judgment should be used to determine if SRPMs will add benefit to the motorists.
<p>If engineering judgment indicates that additional delineation is needed in spot locations, SRPMs may be considered for installation. Potential problems that may justify this special consideration include but are not limited to: high crash locations demonstrating significant crash proportions due to roadway departures, complex intersection configurations, detours, fog-prone areas, and highway segments with wet and nighttime crash histories that could be alleviated with SRPMs.</p>		

## **Section 3B.12 Raised Pavement Markers as Vehicle Positioning Guides with Other Longitudinal Markings**

Option:

- 01 Retroreflective or internally illuminated raised pavement markers may be used as positioning guides with longitudinal line markings without necessarily conveying information to the road user about passing or lane-use restrictions. In such applications, markers may be positioned in line with or immediately adjacent to a single line marking, or positioned between the two lines of a double center line or double lane line marking (see Drawing D of Figure 3B-V2 in this Supplement).



*Guidance:*

- 02 ~~The spacing for such applications should be  $2N$ , where  $N$  equals the length of one line segment plus one gap (see Section 3B.11).~~

**Standard:**

- 03 **For no-passing zones on ~~multi-lane~~ undivided roadways, the maximum spacing for such applications shall be 40 feet. For all other roadways, the maximum spacing for such applications shall be 80 feet.**

**Option:**

- 04 Where it is desired to alert the road user to changes in the travel path, such as on sharp curves or on transitions that reduce the number of lanes or that shift traffic laterally, the spacing may be reduced to 40 feet or less.



- 05 ~~On freeways and expressways, the spacing may be increased to  $3N$  for relatively straight and level roadway segments where engineering judgment indicates that such spacing will provide adequate delineation under wet night conditions.~~

## **Section 3B.13 Raised Pavement Markers Supplementing Other Markings**



**Standard:**

- 01 **The use of retroreflective or internally illuminated raised pavement markers for supplementing longitudinal line markings shall comply with the following requirements for longitudinal maximum spacing:**
- A. When supplementing solid line markings, raised pavement markers spaced no greater than 40 feet shall be used.**
  - B. When supplementing broken line markings (see Drawings A and B of Figure 3B-V2), raised pavement markers spaced no greater than 80 feet shall be used. However, when supplementing broken line markings identifying reversible lanes, raised pavement markers spaced no greater than 40 feet shall be used.**
  - C. When supplementing double line markings, raised pavement markers spaced no greater than 80 feet shall be used.**
  - D. When supplementing the markings used to define a one-way passing zone on a two-lane roadway, raised pavement markers supplementing the solid line shall be spaced no greater than 40 feet. Markers supplementing the broken lines shall be spaced no greater than 80 feet.**

*Guidance:*

- 02 *The use of retroreflective or internally illuminated raised pavement markers for supplementing longitudinal line markings should comply with the following:*

- A. *Lateral Positioning*
1. *When supplementing double line markings, pairs of raised pavement markers placed laterally in line with or immediately outside of the two lines should be used.*
  2. *When supplementing wide line markings, pairs of raised pavement markers placed laterally adjacent to each other should be used.*
- B. *Longitudinal Spacing*
1. *When supplementing dotted lane line markings, spacing appropriate for the application should be used.*
  2. *When supplementing longitudinal line extension markings through at-grade intersections, one raised pavement marker for each short line segment should be used.*
  3. *When supplementing the markings used to define a two-way left turn lane, raised pavement markers should be installed with a spacing of 40 feet, as shown in Drawing E of Figure 3B-V2 in this Supplement.*
- C. *Lateral Spacing*
1. *When supplementing solid line markings, the lateral spacing between the edge of the raised pavement marker and solid line marking should be 3 inches, as shown in Drawing C of Figure 3B-V2 in this Supplement.*
- 03 *Raised pavement markers should not supplement right-hand edge lines unless an engineering study or engineering judgment indicates the benefits of enhanced delineation of a curve or other location would outweigh possible impacts on bicycles using the shoulder, and the spacing of raised pavement markers on the right-hand edge is close enough to avoid misinterpretation as a broken line during wet night conditions.*

**Standard:**

- 04 **When supplementing channelizing lines or edge line markings, a spacing of 20 feet shall be used for raised pavement markers. Placement of markers shall extend a minimum of 80 feet beyond the physical gore (see Drawing F of Figure 3B-V2 in this Supplement).**

**Option:**

- 05 Raised pavement markers may be utilized along the entire channelizing line at exit ramps or entrance ramps if needed for additional delineation, visibility, or emphasis (see Drawing F of Figure 3B-V2 in this Supplement).
- 06 Raised pavement markers also may be used to supplement other markings such as channelizing islands, gore areas, approaches to obstructions, or wrong-way arrows.
- 07 To improve the visibility of horizontal curves, center lines may be supplemented with retroreflective or internally illuminated raised pavement markers for the entire curved section as well as for a distance in advance of the curve that approximates 5 seconds of travel time. The spacing between markers in these applications may be reduced as determined by engineering judgment.





## **Section 3B.14 Raised Pavement Markers Substituting for Pavement Markings**

### **Standard:**



- 01 **Raised pavement markers shall not be used to substitute for pavement markings.**

## **Section 3B.16 Stop and Yield Lines**

### *Guidance:*

- 01 *Stop lines should be used to indicate the point behind which vehicles are required to stop in compliance with a traffic control signal.*

### *Option:*

- 02 *Stop lines may be used to indicate the point behind which vehicles are required to stop in compliance with a STOP (R1-1) sign, a ~~Stop Here For Pedestrians (R1-5b or R1-5c) sign~~, or some other traffic control device that requires vehicles to stop, except YIELD signs that are not associated with passive grade crossings.*

### *Support:*



- 03 *The Code of Virginia § 46.2-924 requires that drivers at crosswalks yield the right-of-way to pedestrians crossing the roadway. The Standard statement in Section 2B.11 of the National MUTCD permits the use of the Stop Here for Pedestrians (R1-5b and R1-5c) signs only if state law specifically requires the driver to stop for a pedestrian in a crosswalk. As The Code of Virginia does not require a driver to stop, the R1-5b and R1-5c signs are not used in Virginia.*

### *Option:*

- 04 *Yield lines may be used to indicate the point behind which vehicles are required to yield in compliance with a YIELD (R1-2) sign or a Yield Here To Pedestrians (R1-5 or R1-5a) sign.*

### **Standard:**

- 05 **Except as provided in Section 8B.28 of the MUTCD, stop lines shall not be used at locations where drivers are required to yield in compliance with a YIELD (R1-2) sign or a Yield Here To Pedestrians (R1-5 or R1-5a) sign or at locations on uncontrolled approaches where drivers are required by State law to yield to pedestrians.**
- 06 **Yield lines shall not be used at locations where drivers are required to stop in compliance with a STOP (R1-1) sign, a ~~Stop Here For Pedestrians (R1-5b or R1-5c) sign~~, a traffic control signal, or some other traffic control device.**
- 07 **Stop lines shall consist of solid white lines extending across approach lanes to indicate the point at which the stop is intended or required to be made.**
- 08 **Yield lines (see Figure 3B-16) shall consist of a row of solid white isosceles triangles pointing toward approaching vehicles extending across approach lanes to indicate the point at which the yield is intended or required to be made.**



- 09 **Stop lines shall be 24 inches wide.**

*Guidance:*

- 10 The individual triangles comprising the yield line should have a base of 12 to 24 inches wide and a height equal to 1.5 times the base. The space between the triangles should be 3 to 12 inches.

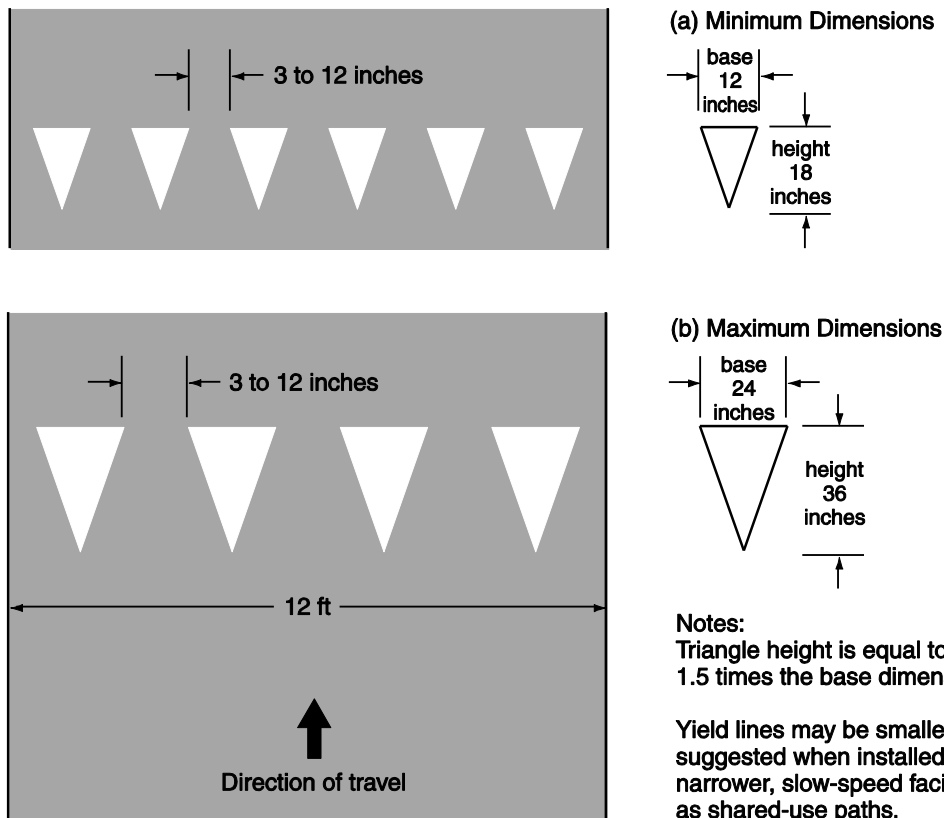
**Standard:**

- 11 If used, stop and yield lines shall be placed a minimum of 4 feet in advance of the nearest crosswalk line at controlled intersections, except for yield lines at roundabouts as provided for in Section 3C.04 of the MUTCD and at midblock crosswalks. In the absence of a marked crosswalk, the stop line or yield line shall be placed at the desired stopping or yielding point, but shall not be placed more than 30 feet or less than 8 feet from the nearest edge of the intersecting traveled way.

*Guidance:*

- 12 Stop lines at midblock signalized locations should be placed at least 40 feet in advance of the nearest signal indication (see Section 4D.14 of the MUTCD).
- 13 If yield or stop lines are used at a crosswalk that crosses an uncontrolled multi-lane approach, the yield lines or stop lines should be placed 20 to 50 feet in advance of the nearest crosswalk line, and parking should be prohibited in the area between the yield or stop line and the crosswalk (see Figure 3B-17(VA) in this Supplement).

### Figure 3B-16. Recommended Yield Line Layouts



**Standard:**

- 14 **If yield (~~stop~~) lines are used at a crosswalk that crosses an uncontrolled multi-lane approach, Yield Here To (~~Stop Here For~~) Pedestrians (R1-5 series) signs (see Section 2B.11 of this Supplement) shall be used.**

*Guidance:*

- 15 *Yield (~~stop~~) lines and Yield Here To (~~Stop Here For~~) Pedestrians signs should not be used in advance of crosswalks that cross an approach to or departure from a roundabout.*

**Support:**

- 16 When drivers yield or stop too close to crosswalks that cross uncontrolled multi-lane approaches, they place pedestrians at risk by blocking other drivers' views of pedestrians and by blocking pedestrians' views of vehicles approaching in the other lanes.

**Option:**

- 17 Stop and yield lines may be staggered longitudinally on a lane-by-lane basis (see Drawing D of Figure 3B-13(VA) in this Supplement).

**Support:**

- 18 Staggered stop lines and staggered yield lines can improve the driver's view of pedestrians, provide better sight distance for turning vehicles, and increase the turning radius for left-turning vehicles.
- 19 Section 8B.28 of the MUTCD contains information regarding the use of stop lines and yield lines at grade crossings.

## Section 3B.18 Crosswalk Markings

**Support:**

- 01 Crosswalk markings provide guidance for pedestrians who are crossing roadways by defining and delineating paths on approaches to and within signalized intersections, and on approaches to other intersections where traffic stops.
- 02 In conjunction with signs and other measures, crosswalk markings help to alert road users of a designated pedestrian crossing point across roadways at locations that are not controlled by traffic control signals or STOP or YIELD signs.
- 03 At non-intersection locations, crosswalk markings legally establish the crosswalk.

**Standard:**

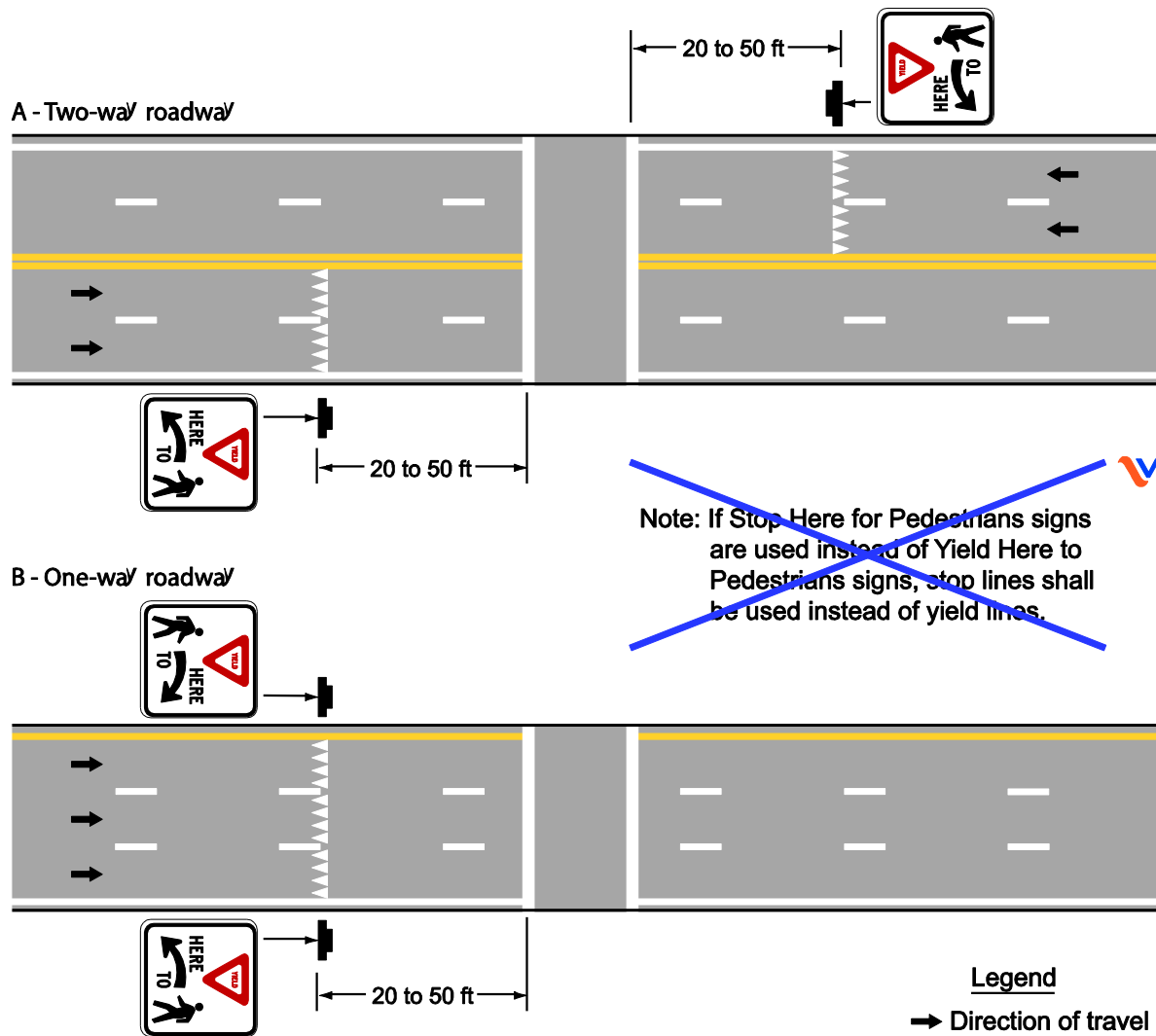
- 04 **When crosswalk lines are used, they shall consist of solid white lines that mark the crosswalk. They shall not be less than 6 inches or greater than 24 inches in width.**

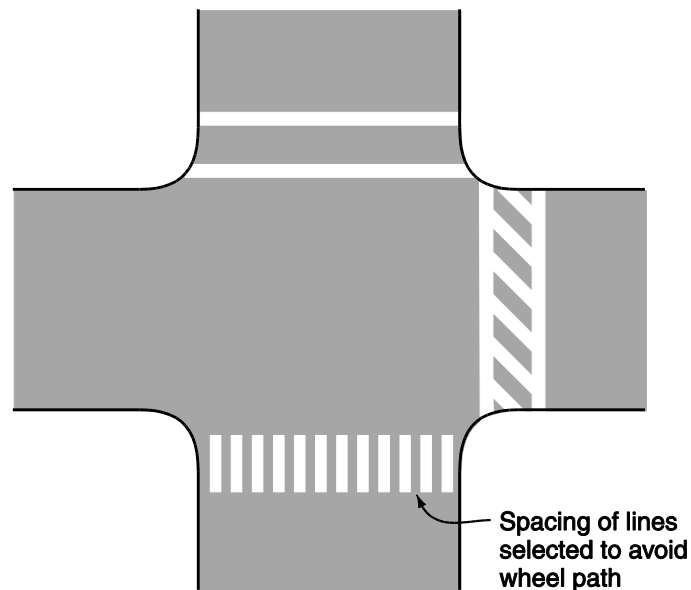
*Guidance:*

- 05 *If transverse lines are used to mark a crosswalk, the gap between the lines should not be less than 6 feet. If diagonal or longitudinal lines are used without transverse lines to mark a crosswalk, the crosswalk should be not less than 6 feet wide.*

- 06 *Crosswalk lines, if used on both sides of the crosswalk, should extend across the full width of pavement or to the edge of the intersecting crosswalk to discourage diagonal walking between crosswalks (see Figures 3B-17(VA) in this Supplement and 3B-19).*
- 07 *At locations controlled by traffic control signals or on approaches controlled by STOP or YIELD signs, crosswalk lines should be installed where engineering judgment indicates they are needed to direct pedestrians to the proper crossing path(s).*

**Figure 3B-17(VA). Examples of Yield Lines at Unsignalized Midblock Crosswalks**



**Figure 3B-19. Examples of Crosswalk Markings**

- 08 *Crosswalk lines should not be used indiscriminately. An engineering study should be performed before a marked crosswalk is installed at a location away from a traffic control signal or an approach controlled by a STOP or YIELD sign. The engineering study should consider the number of lanes, the presence of a median, the distance from adjacent signalized intersections, the pedestrian volumes and delays, the average daily traffic (ADT), the posted or statutory speed limit or 85th-percentile speed, the geometry of the location, the possible consolidation of multiple crossing points, the availability of street lighting, and other appropriate factors.*
- 09 *New marked crosswalks alone, without other measures designed to reduce traffic speeds, shorten crossing distances, enhance driver awareness of the crossing, and/or provide active warning of pedestrian presence, should not be installed across uncontrolled roadways where the speed limit exceeds 40 mph and either:*
- A. The roadway has four or more lanes of travel without a raised median or pedestrian refuge island and an ADT of 12,000 vehicles per day or greater; or*
  - B. The roadway has four or more lanes of travel with a raised median or pedestrian refuge island and an ADT of 15,000 vehicles per day or greater.*
- Support:
- 10 Chapter 4F contains information on Pedestrian Hybrid Beacons. [Section 4L.03 of the MUTCD](#) contains information regarding Warning Beacons to provide active warning of a pedestrian's presence. [Section 4N.02 of this Supplement](#) contains information regarding In-Roadway Warning Lights at crosswalks. Chapter 7D contains information regarding school crossing supervision.

*Guidance:*

- 11 *Because non-intersection pedestrian crossings are generally unexpected by the road user, warning signs (see [Section 2C.50 of this Supplement](#)) should be installed for all marked crosswalks at non-intersection locations and adequate visibility should be provided by parking prohibitions.*

## Support:

- 12 [Section 3B.16 of this Supplement](#) contains information regarding placement of stop line markings near crosswalk markings.

## Option:

- 13 For added visibility, the area of the crosswalk may be marked with white diagonal lines at a 45-degree angle to the line of the crosswalk or with white longitudinal lines parallel to traffic flow as shown in Figure 3B-19.
- 14 When diagonal or longitudinal lines are used to mark a crosswalk, the transverse crosswalk lines may be omitted. This type of marking may be used at locations where substantial numbers of pedestrians cross without any other traffic control device, at locations where physical conditions are such that added visibility of the crosswalk is desired, or at places where a pedestrian crosswalk might not be expected.

*Guidance:*

- 15 *If used, the diagonal or longitudinal lines should be 12 to 24 inches wide and separated by gaps of 12 to 60 inches. The design of the lines and gaps should avoid the wheel paths if possible, and the gap between the lines should not exceed 2.5 times the width of the diagonal or longitudinal lines.*

## Option:

- 16 When an exclusive pedestrian phase that permits diagonal crossing of an intersection is provided at a traffic control signal, a marking as shown in Figure 3B-20 may be used for the crosswalk.

*Guidance:*

- 17 *Crosswalk markings should be located so that the curb ramps are within the extension of the crosswalk markings.*

## Support:

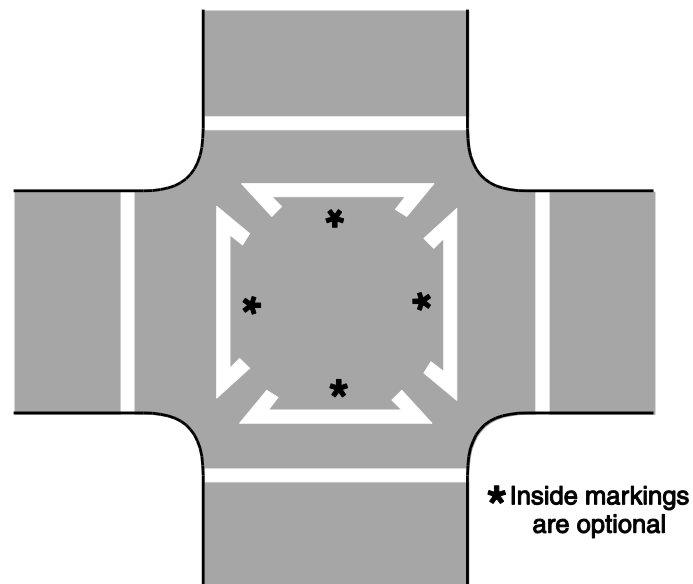
- 18 Detectable warning surfaces mark boundaries between pedestrian and vehicular ways where there is no raised curb. Detectable warning surfaces are required by 49 CFR, Part 37 and by the Americans with Disabilities Act (ADA) where curb ramps are constructed at the junction of sidewalks and the roadway, for marked and unmarked crosswalks. Detectable warning surfaces contrast visually with adjacent walking surfaces, either light-on-dark, or dark-on-light. The "Americans with Disabilities Act Accessibility Guidelines for Buildings and Facilities (ADAAG)" (see [Section 1A.11 of this Supplement](#)) contains specifications for design and placement of detectable warning surfaces.

## Support:

- 19 Information regarding guidelines and recommendations for crosswalk markings can be found in VDOT's "Guidelines for the Installation of Marked Crosswalks" (see link in Appendix A of this Supplement).



**Figure 3B-20. Example of Crosswalk Markings for an Exclusive Pedestrian Phase that Permits Diagonal Crossing**



## **Section 3B.19 Parking Space Markings**

### Support:

- 01 Marking of parking space boundaries encourages more orderly and efficient use of parking spaces where parking turnover is substantial. Parking space markings tend to prevent encroachment into fire hydrant zones, bus stops, loading zones, approaches to intersections, curb ramps, and clearance spaces for islands and other zones where parking is restricted. Examples of parking space markings are shown in Figure 3B-21.

### Standard:

- 02 **Parking space markings shall be white.**

### Option:

- 03 Blue lines may supplement white parking space markings of each parking space designated for use only by persons with disabilities.

### Support:

- 04 Additional parking space markings for the purpose of designating spaces for use only by persons with disabilities are discussed in [Section 3B.20 of this Supplement](#) and illustrated in [Figure 3B-22\(VA\) in this Supplement](#). The design and layout of accessible parking spaces for persons with disabilities is provided in the "Americans with Disabilities Act Accessibility Guidelines (ADAAG)" (see [Section 1A.11 of this Supplement](#)).

**Standard:**

- 05 **The International Symbol of Accessibility Parking Space Marking shall be 41 inches in height and 36 inches in width, as shown in Figure 3B-22(VA) in this Supplement. A 4-inch stroke width shall be used for the symbol lines.**

## **Section 3B.20 Pavement Word, Symbol, and Arrow Markings**

**Support:**

- 01 Word, symbol, and arrow markings on the pavement are used for the purpose of guiding, warning, or regulating traffic. These pavement markings can be helpful to road users in some locations by supplementing signs and providing additional emphasis for important regulatory, warning, or guidance messages, because the markings do not require diversion of the road user's attention from the roadway surface. Symbol messages are preferable to word messages. Examples of standard word and arrow pavement markings are shown in Figures 3B-23 and 3B-24(VA) in this Supplement.

**Option:**

- 02 Word, symbol, and arrow markings, including those contained in the "Standard Highway Signs and Markings" book (see [Section 1A.11 of this Supplement](#)), may be used as determined by engineering judgment to supplement signs and/or to provide additional emphasis for regulatory, warning, or guidance messages. Among the word, symbol, and arrow markings that may be used are the following:

**A. Regulatory:**

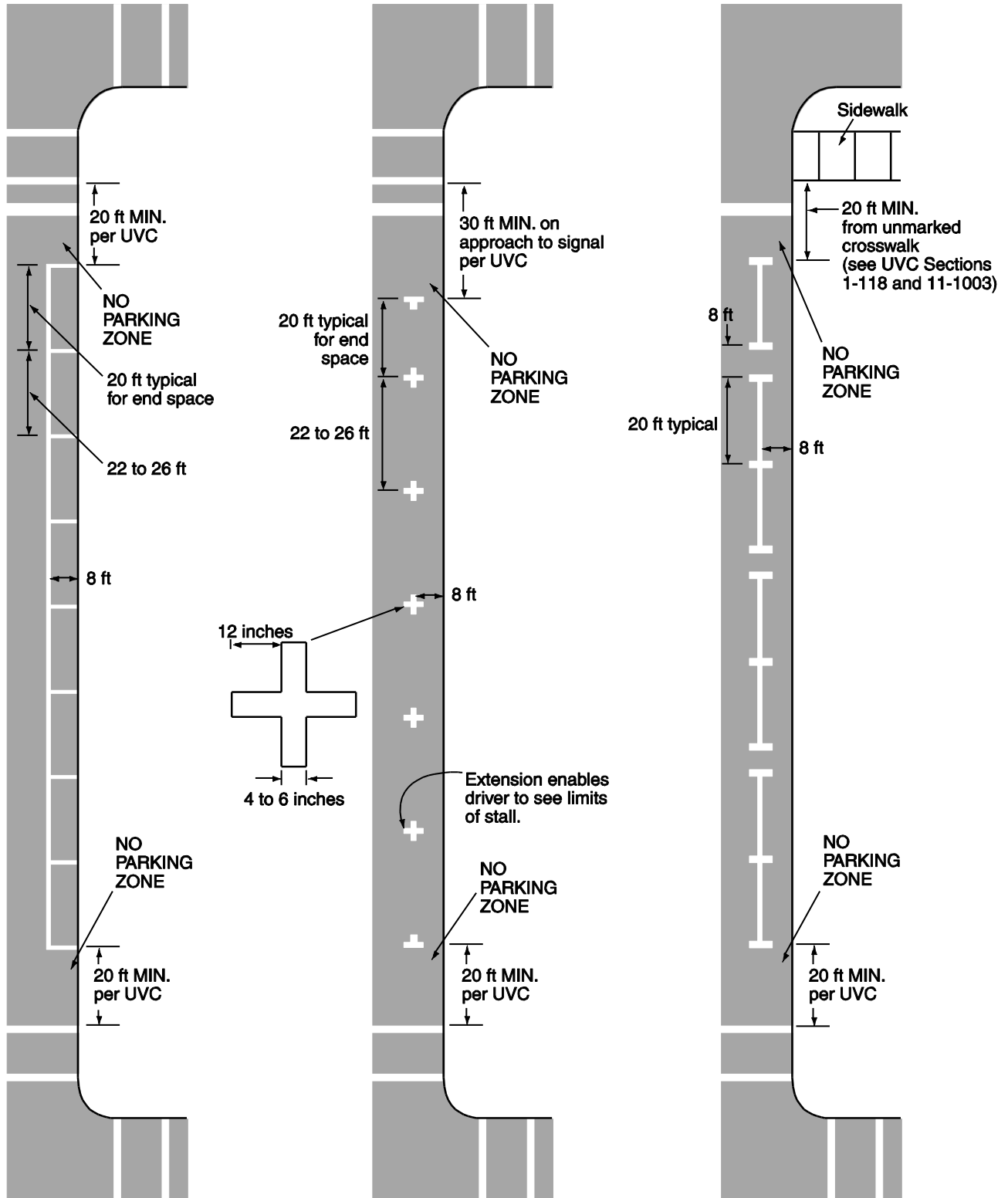
1. STOP
2. YIELD
3. RIGHT (LEFT) TURN ONLY
4. 25 MPH
5. Lane-use and wrong-way arrows
6. Diamond symbol for HOV lanes
7. Other preferential lane word markings

**B. Warning:**

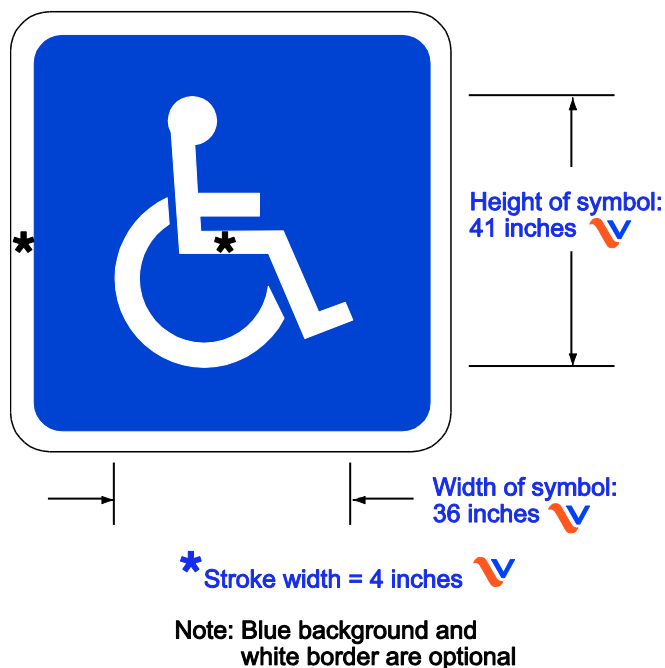
1. STOP AHEAD
2. YIELD AHEAD
3. YIELD AHEAD triangle symbol
4. SCHOOL XING
5. SIGNAL AHEAD
6. PED XING
7. SCHOOL
8. R X R



**Figure 3B-21. Examples of Parking Space Markings**



## Figure 3B-22(VA). International Symbol of Accessibility Parking Space Marking



9. BUMP
10. HUMP
11. Lane-reduction arrows

### C. Guide:

1. Route numbers (route shield pavement marking symbols and/or words such as I-81, US 40, STATE 135, or ROUTE 10)
2. Cardinal directions (NORTH, SOUTH, EAST, or WEST)
3. TO
4. Destination names or abbreviations thereof

### Standard:

- 03 **Word, symbol, and arrow markings shall be white, except as otherwise provided in this Section.**
- 04 **Pavement marking letters, numerals, symbols, and arrows shall be installed in accordance with the design details in the Pavement Markings chapter of the "Standard Highway Signs and Markings" book (see [Section 1A.11 of this Supplement](#)).**

## Figure 3B-23. Example of Elongated Letters for Word Pavement Markings



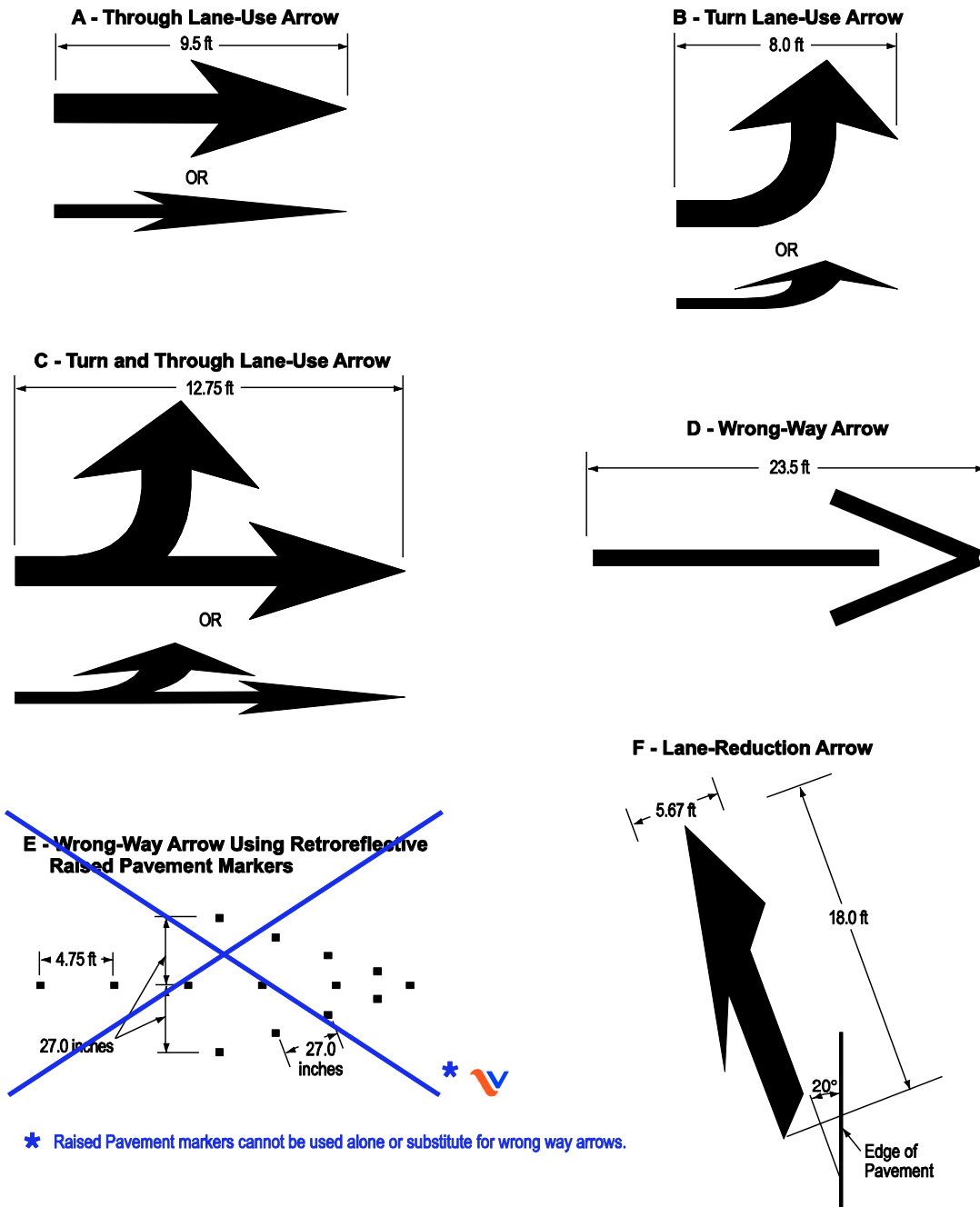
### Guidance:

- 05 *Letters and numerals should be 6 feet or more in height.*
- 06 *Word and symbol markings should not exceed three lines of information.*
- 07 *If a pavement marking word message consists of more than one line of information, it should read in the direction of travel. The first word of the message should be nearest to the road user.*
- 08 *Except for the two opposing arrows of a two-way left-turn lane marking (see Figure 3B-7), the longitudinal space between word or symbol message markings, including arrow markings, should be at least four times the height of the characters for low-speed roads, but not more than ten times the height of the characters under any conditions.*
- 09 *The number of different word and symbol markings used should be minimized to provide effective guidance and avoid misunderstanding.*
- 10 *Except for the SCHOOL word marking (see [Section 7C.03 of the MUTCD](#)), pavement word, symbol, and arrow markings should be no more than one lane in width.*
- 11 *Pavement word, symbol, and arrow markings should be proportionally scaled to fit within the width of the facility upon which they are applied.*

### Option:

- 12 *On narrow, low-speed shared-use paths, the pavement words, symbols, and arrows may be smaller than suggested, but to the relative scale.*
- 13 *Pavement markings simulating Interstate, U.S., State, and other official highway route shield signs (see [Figure 2D-3\(VA\) in this Supplement](#)) with appropriate route numbers, but elongated for proper proportioning when viewed as a marking, may be used to guide road users to their destinations (see Figure 3B-25).*

**Figure 3B-24(VA). Examples of Standard Arrows for Pavement Markings**



\* Raised Pavement markers cannot be used alone or substitute for wrong way arrows.

**Notes:**

1. Typical sizes for normal installation; sizes may be reduced approximately one-third for low-speed urban conditions; larger sizes may be needed for freeways, above average speeds, and other critical locations.
2. The narrow elongated arrow designs shown in Drawings A, B, and C are optional.
3. For proper proportion, see the Pavement Markings chapter of the "Standard Highway Signs and Markings" book (see Section 1A.11).

**Standard:**

- 14 **Except at the ends of aisles in parking lots, the word STOP shall not be used on the pavement unless accompanied by a stop line (see [Section 3B.16 in this Supplement](#)) and STOP sign (see [Section 2B.05 of the MUTCD](#)). At the ends of aisles in parking lots, the word STOP shall not be used on the pavement unless accompanied by a stop line.**
- 15 **The word STOP shall not be placed on the pavement in advance of a stop line, unless every vehicle is required to stop at all times.**

## Option:

- 16 A yield-ahead triangle symbol (see Figure 3B-26) or YIELD AHEAD word pavement marking may be used on approaches to intersections where the approaching traffic will encounter a YIELD sign at the intersection.

**Standard:**

- 17 **The yield-ahead triangle symbol or YIELD AHEAD word pavement marking shall not be used unless a YIELD sign (see [Section 2B.08 of the MUTCD](#)) is in place at the intersection. The yield-ahead symbol marking shall be as shown in Figure 3B-26.**

*Guidance:*

- 18 *The International Symbol of Accessibility parking space marking (see [Figure 3B-22\(VA\) in this Supplement](#)) should be placed in each parking space designated for use by persons with disabilities.*

## Option:

- 19 A blue background with white border may supplement the wheelchair symbol as shown in [Figure 3B-22\(VA\) in this Supplement](#).

## Support:

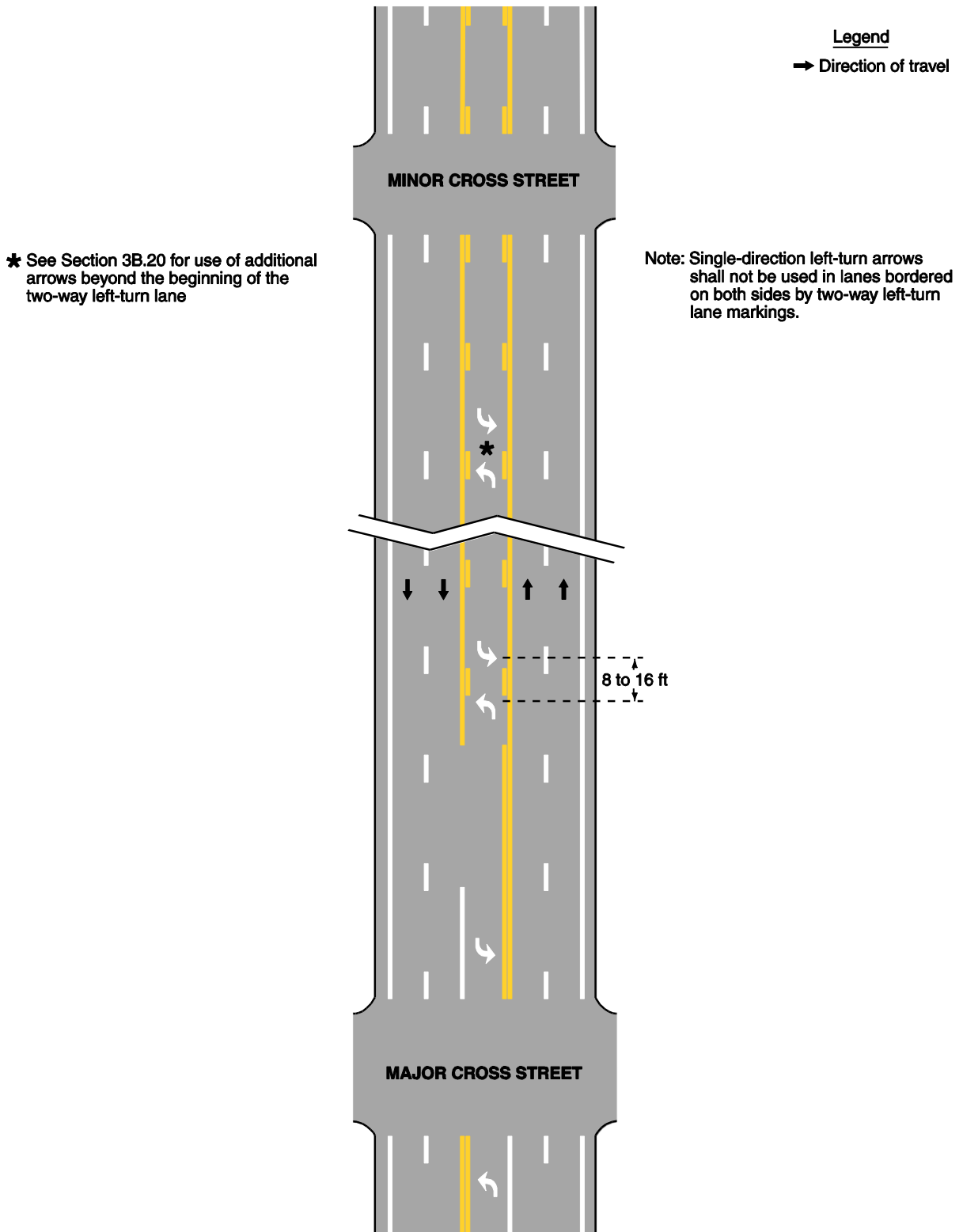
- 20 Lane-use arrow markings (see [Figure 3B-24\(VA\) in this Supplement](#)) are used to indicate the mandatory or permissible movements in certain lanes (see [Figure 3B-27\(VA\) in this Supplement](#)) and in two-way left-turn lanes (see Figure 3B-7).

*Guidance:*

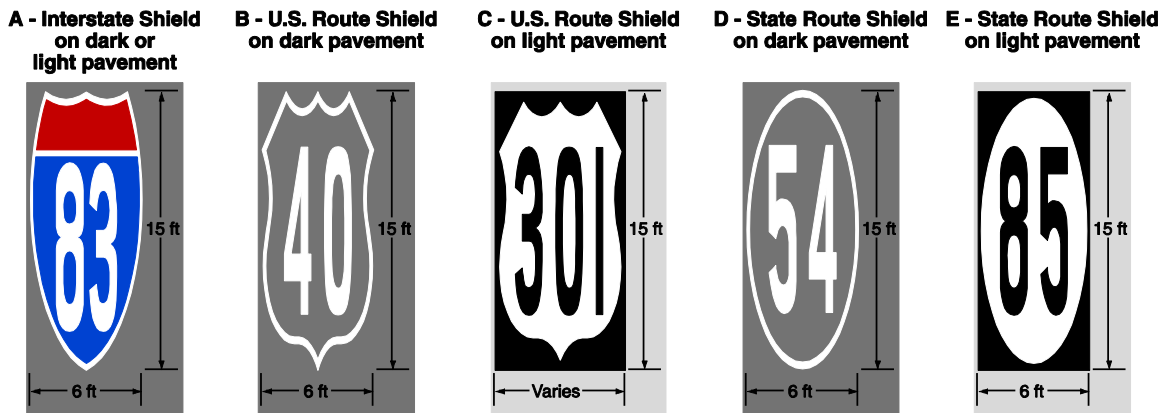
- 21 *Lane-use arrow markings (see [Figure 3B-24\(VA\) in this Supplement](#)) should be used in lanes designated for the exclusive use of a turning movement, including turn bays, except where engineering judgment determines that physical conditions or other markings (such as a dotted extension of the lane line through the taper into the turn bay) clearly discourage unintentional use of a turn bay by through vehicles. Lane-use arrow markings should also be used in lanes from which movements are allowed that are contrary to the normal rules of the road (see [Drawing B of Figure 3B-13\(VA\) in this Supplement](#)).*
- 22 *When used in turn lanes 300 feet in length or less, exclusive of taper, two arrows should be placed, one at the upstream end of the full-width turn lane and one located 50 feet upstream from the stop line, except as provided in Paragraph 24. When used in turn lanes greater than 300 feet in length, exclusive of taper, an additional arrow should be placed at the midpoint of the two arrows used in shorter turn lanes.*



### Figure 3B-7. Example of Two-Way, Left-Turn Lane Marking Applications



## Figure 3B-25. Examples of Elongated Route Shields for Pavement Markings



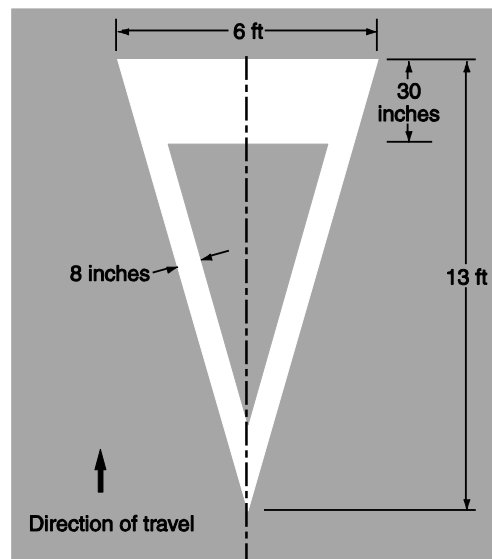
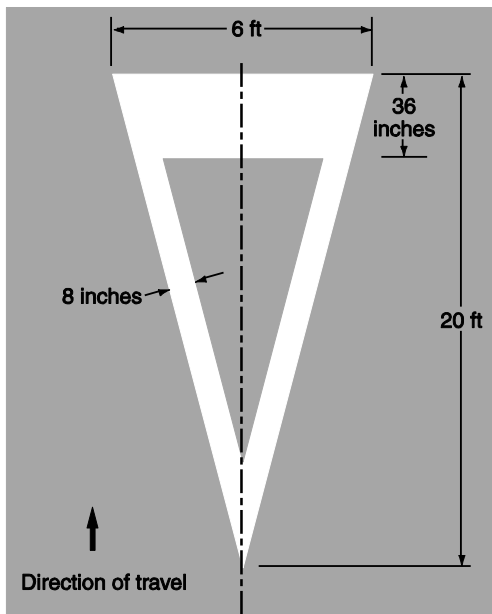
**Notes:**

1. See the "Standard Highway Signs and Markings" book for other sizes and details
2. Colors and elongated shapes simulating State route shield signs may be used for route shield pavement markings where appropriate

## Figure 3B-26. Yield Ahead Triangle Symbols

**A - Posted or Statutory Speed Limit of 45 mph or greater**

**B - Posted or Statutory Speed Limit of less than 45 mph**



**Support:**

- 23 Figure 3B-11(VA) in this Supplement shows examples of lane-use control and arrow pavement markings.

**Option:**

- 24 An additional arrow or arrows may be used in a turn lane. When arrows are used for a short turn lane, the second (downstream) arrow may be omitted based on engineering judgment.

**Guidance:**

- 25 *Where opposing offset channelized left-turn lanes exist, lane-use arrow markings should be placed near the downstream terminus of the offset left-turn lanes to reduce wrong-way movements (see Figure 2B-17 of the MUTCD).*

**Support:**

- 26 An arrow at the downstream end of a turn lane can help to prevent wrong way movements.

**Standard:**

- 27 **Where through lanes approaching an intersection become mandatory turn lanes, lane-use arrow markings (see Figure 3B-24(VA) in this Supplement) shall be used and shall be accompanied by standard signs. Where through lanes approaching an intersection become mandatory turn lanes, ONLY word markings (see Figure 3B-23) shall be used in addition to the required lane-use arrow markings and signs (see Sections 2B.19 and 2B.20 of the MUTCD).**

**Guidance:**

- 28 *These markings and signs should be placed well in advance of the turn and should be repeated as necessary to prevent entrapment and to help the road user select the appropriate lane in advance of reaching a queue of waiting vehicles (see Figure 3B-11(VA) in this Supplement).*

- 29 *Where dual turn lanes exist, ONLY word markings (see Figure 3B-23) should be used in addition to the required lane-use arrow markings and signs (see Sections 2B.19 and 2B.20 of the MUTCD). These markings and signs should be placed and repeated as necessary to help the road user select the appropriate lane in advance of reaching a queue of waiting vehicles.*

**Option:**

- 30 On freeways or expressways where a through lane becomes a mandatory exit lane, lane-use arrow markings may be used on the approach to the exit in the dropped lane and in an adjacent optional through-or-exit lane if one exists.

**Guidance:**

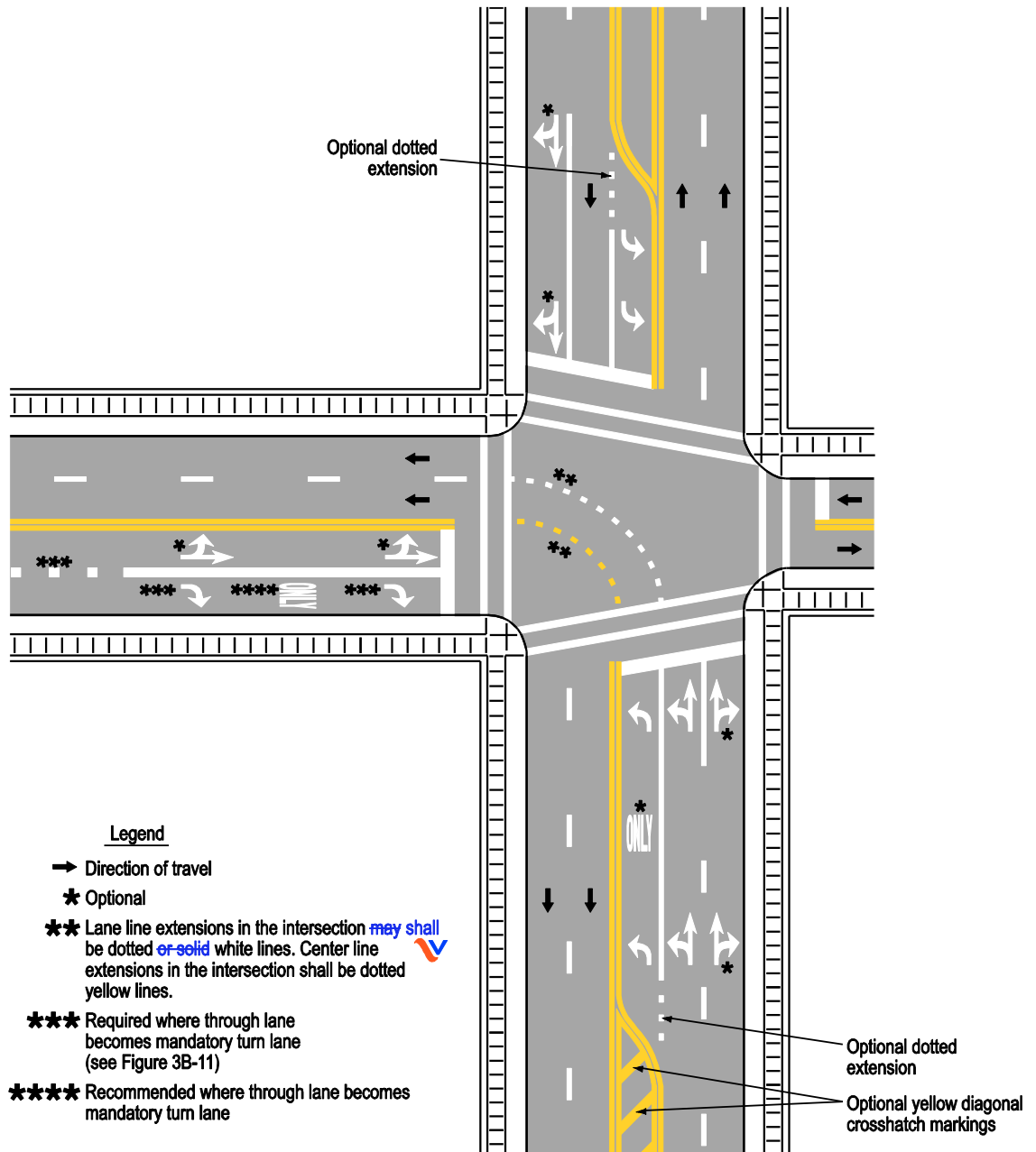
- 31 *A two-way left-turn lane-use arrow pavement marking, with opposing arrows spaced as shown in Figure 3B-7, should be used at or just downstream from the beginning of a two-way left-turn lane.*

**Option:**

- 32 Additional two-way left-turn lane-use arrow markings may be used at other locations along a two-way left-turn lane where engineering judgment determines that such additional markings are needed to emphasize the proper use of the lane.



**Figure 3B-27(VA). Examples of Lane-Use Control Word and Arrow Pavement Markings**



**Standard:**

- 33 **A single-direction lane-use arrow shall not be used in a lane bordered on both sides by yellow two-way left-turn lane longitudinal markings.**
- 34 **Lane-use, lane-reduction, and wrong-way arrow markings shall be designed as shown in [Figure 3B-24\(VA\)](#) in this Supplement and in the "Standard Highway Signs and Markings" and "Virginia Standard Highway Signs" books (see [Section 1A.11](#) of this Supplement).**

## Option:

- 35 The ONLY word marking (see [Figure 3B-23](#)) may be used to supplement the lane-use arrow markings in lanes that are designated for the exclusive use of a single movement (see [Figure 3B-27\(VA\)](#) in this Supplement) or to supplement a preferential lane word or symbol marking (see [Section 3D.01](#) of this Supplement).

**Standard:**

- 36 **The ONLY word marking shall not be used in a lane that is shared by more than one movement.**



- 37 **Where a lane-reduction transition occurs on a roadway with a speed limit of 45 mph or more, the lane-reduction arrow markings shown in [Drawing F](#) in [Figure 3B-24\(VA\)](#) in this Supplement shall be used (see [Figure 3B-14](#)).**

*Guidance:*

- 38 *Except for acceleration lanes, where a lane-reduction transition occurs on a roadway with a speed limit of less than 45 mph, the lane-reduction arrow markings shown in [Drawing F](#) in [Figure 3B-24\(VA\)](#) in this Supplement should be used if determined to be appropriate based on engineering judgment.*

**Standard:**

- 39 **Where crossroad channelization or ramp geometrics do not make wrong-way movements difficult, the appropriate lane-use arrow shall be placed in each lane of an exit ramp near the crossroad terminal where it will be clearly visible to a potential wrong-way road user (see [Figure 2B-18\(VA\)](#) in this Supplement).**
- 40 **The wrong-way arrow markings shown in [Drawing D](#) in [Figure 3B-24\(VA\)](#) in this Supplement shall be placed near the downstream terminus of a ramp (see [Figure 2B-18\(VA\)](#) in this Supplement).**

## Option:

- 41 Wrong-way arrow markings may be placed at other locations where lane-use arrows are not appropriate, to indicate the correct direction of traffic flow and to discourage drivers from traveling in the wrong direction.

## **Section 3B.21 Speed Measurement Markings**

## Support:

- 01 A speed measurement marking is a transverse marking placed on the roadway to assist the enforcement of speed regulations.



- 02 The Virginia General Assembly enacted legislation, effective July 1, 2000, amending § 46.2-882 of the Code of Virginia to allow the use of aircraft for enforcement of the speed limit on interstate highways. Speed measurement markings are used by the Virginia State Police with the Visual Average Speed Computer and Monitor (VASCAR) units within aircraft as a point of reference to determine the speed of vehicles.

**Standard:**

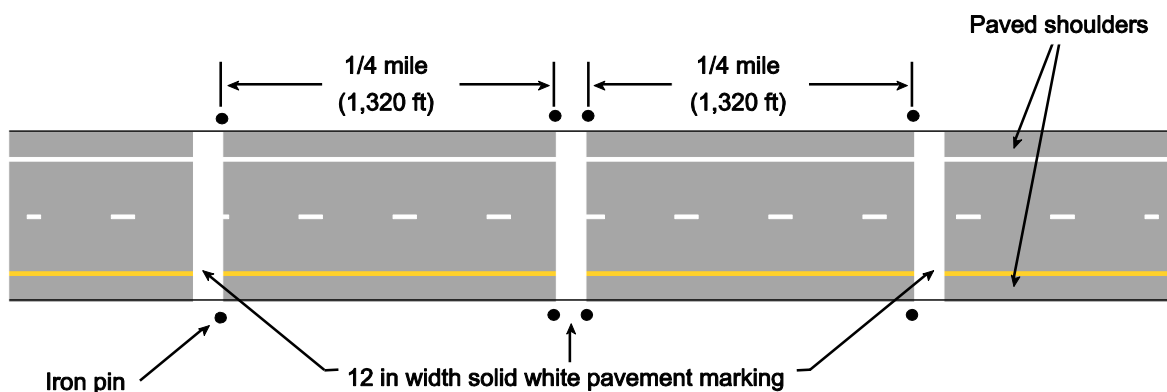
- 03 **Speed measurement markings shall be solid white and shall be 12 inches wide, extending between the edges of the pavement on either side of the roadway. The markings shall be installed according to Figure 3B-V3 in this Supplement at locations on interstate highways determined by the Virginia State Police.**
- 04 **The location of the pavement marking at each site shall be determined using iron pins located as shown in Figure 3B-V3 in this Supplement. The pin locations shall be determined with survey equipment that will provide accuracy within three to five hundredths of a foot for each pin location. Pin locations shall be one foot from the paved shoulder at the locations shown in Figure 3B-V3 in this Supplement. When the paved shoulder continues to a barrier, etc., the pin shall be located as close to the barrier, etc. as possible. The edge of pavement markings shall align with the center of the iron pins on both sides of the roadway**

**Support:**

- 05 See Section 2B-V3 of this Supplement for regulatory signs that are used at or near the State boundary and after major interchanges.



### Figure 3B-V3. Pavement Marking Detail Aerial Speed Enforcement



## Section 3B.24 Chevron and Diagonal Crosshatch Markings

Option:

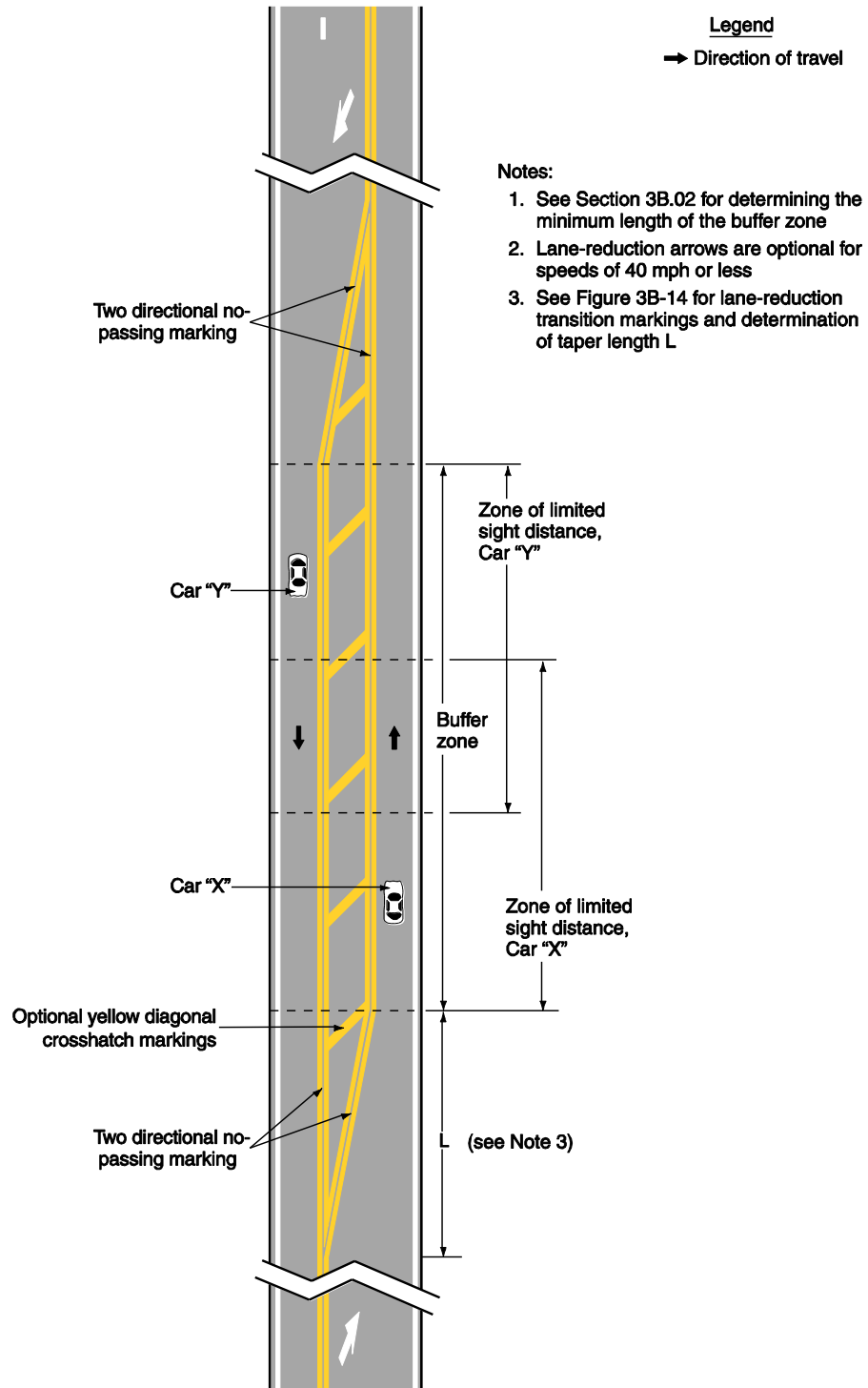
- 01 Chevron and diagonal crosshatch markings may be used to discourage travel on certain paved areas, such as shoulders, gore areas, flush median areas between solid double yellow center line markings or between white channelizing lines approaching obstructions in the roadway (see [Section 3B.10 of the MUTCD](#) and Figure 3B-15), between solid double yellow center line markings forming flush medians or channelized travel paths at intersections (see Figures 3B-2 and 3B-5), buffer spaces between preferential lanes and general-purpose lanes (see [Figures 3D-2\(VA\) in this Supplement](#) and 3D-4), and at grade crossings (see Part 8).

**Standard:**

- 02 **When crosshatch markings are used in paved areas that separate traffic flows in the same general direction, they shall be white and they shall be shaped as chevron markings, with the point of each chevron facing toward approaching traffic, as shown in [Figure 3B-8\(VA\)](#), Drawing A of [Figure 3B-9\(VA\)](#), [Figure 3B-10\(VA\) in this Supplement](#), and Drawing C of Figure 3B-15.**
- 03 **When crosshatch markings are used in paved areas that separate opposing directions of traffic, they shall be yellow diagonal markings that slant away from traffic in the adjacent travel lanes, as shown in Figures 3B-2 and 3B-5 and Drawings A and B of Figure 3B-15.**
- 04 **When crosshatch markings are used on paved shoulders, they shall be diagonal markings that slant away from traffic in the adjacent travel lane. The diagonal markings shall be yellow when used on the left-hand shoulders of the roadways of divided highways and on the left-hand shoulders of one-way streets or ramps. The diagonal markings shall be white when used on right-hand shoulders.**
- 05 **The chevrons and diagonal lines used for crosshatch markings shall be at least 12 inches wide for roadways having a posted or statutory speed limit of 45 mph or greater, and at least 8 inches wide for roadways having posted or statutory speed limit of less than 45 mph. The longitudinal spacing of the chevrons or diagonal lines shall be determined by engineering judgment considering factors such as speeds and desired visual impacts. The chevrons and diagonal lines shall form approximately a 45-degree angle with the longitudinal lines that they intersect.**
- 06 **On limited access highways, the chevrons and diagonal lines used for crosshatch markings shall be at least 24 inches wide. The longitudinal spacing of the chevrons or diagonal lines shall be three times the width of the crosshatch markings (see [Figure 3B-V4 in this Supplement](#)).**

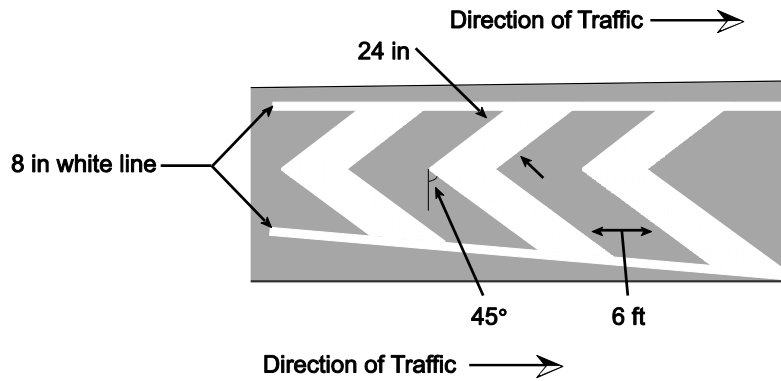


**Figure 3B-5. Example of Application of Three-Lane, Two-Way Marking for Changing Direction of the Center Lane**





## Figure 3B-V4. Chevron Cross Hatch Marking for Limited-Access Highways



## Section 3B.V1 Breaks in Longitudinal Lines at Intersections

### *Guidance:*

- 01 *Breaks in center line markings, lane line markings, edge line markings, and other longitudinal markings should be made only at intersections with public roads. Breaks should be of sufficient length to accommodate traffic entering and leaving the side road.*

# CHAPTER 3D: MARKINGS FOR PREFERENTIAL LANES

## Section 3D.01 Preferential Lane Word and Symbol Markings

### Support:

- 01 Preferential lanes are established for one or more of a wide variety of special uses, including, but not limited to, high-occupancy vehicle (HOV) lanes, ETC lanes, high-occupancy toll (HOT) lanes, bicycle lanes, bus only lanes, taxi only lanes, and light rail transit only lanes.

### Standard:

- 02 When a lane is assigned full or part time to a particular class or classes of vehicles, the preferential lane word and symbol markings described in this Section and the preferential lane longitudinal markings described in [Section 3D.02 of this Supplement](#) shall be used.
- 03 All longitudinal pavement markings, as well as word and symbol pavement markings, associated with a preferential lane shall end where the Preferential Lane Ends (R3-12a or R3-12c) sign (see [Section 2G.07 of the MUTCD](#)) designating the downstream end of the preferential only lane restriction is installed.
- 04 Static or changeable message regulatory signs (see [Sections 2G.03 to 2G.07 of the MUTCD](#)) shall be used with preferential lane word or symbol markings.
- 05 All preferential lane word and symbol markings shall be white and shall be positioned laterally in the center of the preferential lane.
- 06 Where a preferential lane use exists contiguous to a general-purpose lane or is separated from a general purpose lane by a flush buffered space that can be traversed by motor vehicles, the preferential lane shall be marked with one or more of the following symbol or word markings for the preferential lane use specified:



A. HOV lane—the preferential lane-use marking for high-occupancy vehicle lanes shall consist of white lines formed in a diamond shape symbol ~~or the word message~~ **HOV**. The diamond shall be at least 2.5 feet wide and 12 feet in length. The lines shall be at least 6 inches in width.

B. HOT lane or ETC Account-Only lane—except as provided in Paragraph 8, the preferential lane-use marking for a HOT lane or an ETC Account-Only lane shall consist of a word marking using the name of the ETC payment system required for use of the lane, such as E-Z PASS ONLY.



C. Bicycle lane—the preferential lane-use marking for a bicycle lane shall consist of a **helmeted bicyclist** symbol ~~or the word marking~~ **BIKE LANE** (see Chapter 9C and [Figures 9C-1\(VA\) and 9C-3\(VA\) through 9C-6\(VA\) in this Supplement](#)).

- D. **Bus only lane**—the preferential lane-use marking for a bus only lane shall consist of the word marking **BUS ONLY**.
  - E. **Taxi only lane**—the preferential lane-use marking for a taxi only lane shall consist of the word marking **TAXI ONLY**.
  - F. **Light rail transit lane**—the preferential lane-use marking for a light rail transit lane shall consist of the word marking **LRT ONLY**.
  - G. **Other type of preferential lane**—the preferential lane-use markings shall consist of a word marking appropriate to the restriction.
- 07 **If two or more preferential lane uses are permitted in a single lane, the symbol or word marking for each preferential lane use shall be installed.**

**Option:**

- 08 For HOV lanes and bicycle lanes, the word messages may be used to supplement symbol markings on a limited basis if engineering judgment determines a need for them. Such circumstances include new installations of the preferential lane type in a new area of Virginia where drivers may be less familiar with the meaning of the symbols.
- 09 Preferential lane-use symbol or word markings may be omitted at toll plazas where physical conditions preclude the use of the markings (see [Section 3E.01 of the MUTCD](#)).

*Guidance:*

- 10 *The spacing of the markings should be based on engineering judgment that considers the prevailing speed, block lengths, distance from intersections, and other factors that affect clear communication to the road user.*

**Support:**

- 11 Markings spaced as close as 80 feet apart might be appropriate on city streets, while markings spaced as far as 1,000 feet apart might be appropriate for freeways.

*Guidance:*

- 12 *In addition to a regular spacing interval, the preferential lane marking should be placed at strategic locations such as major decision points, direct exit ramp departures from the preferential lane, and along access openings to and from adjacent general-purpose lanes. At decision points, the preferential lane marking should be placed on all applicable lanes and should be visible to approaching traffic for all available departures. At direct exits from preferential lanes where extra emphasis is needed, the use of word markings (such as "EXIT" or "EXIT ONLY") in the deceleration lane for the direct exit and/or on the direct exit ramp itself just beyond the exit gore should be considered.*

**Option:**

- 13 A numeral indicating the vehicle occupancy requirements established for a high-occupancy vehicle lane may be included in sequence after the diamond symbol or HOV word message.

*Guidance:*

- 14 *Engineering judgment should determine the need for supplemental devices such as tubular markers, traffic cones, or other channelizing devices (see Chapter 3H).*





## **Section 3D.02 Preferential Lane Longitudinal Markings for Motor Vehicles**

Support:

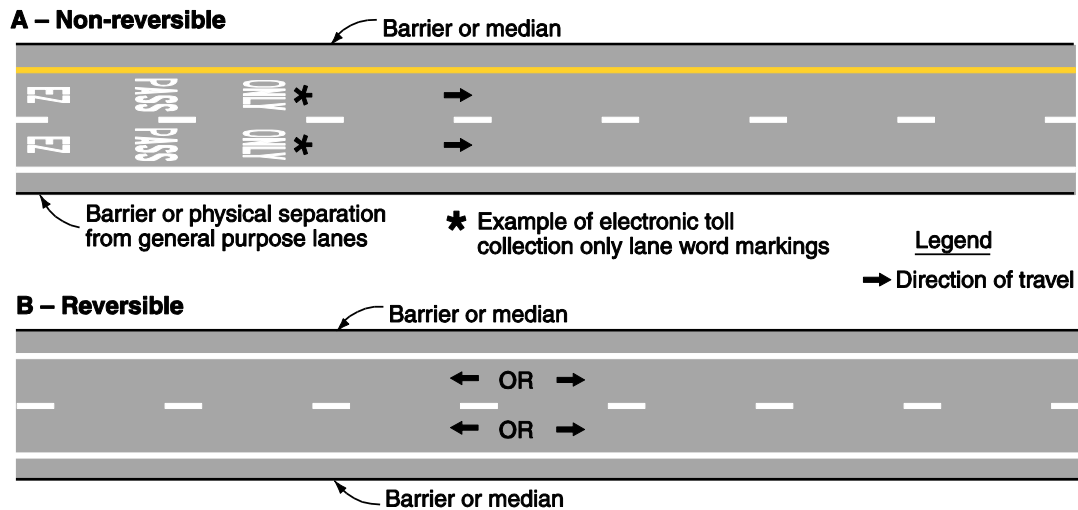
- 01 Preferential lanes can take many forms depending on the level of usage and the design of the facility. They might be barrier-separated or buffer-separated from the adjacent general-purpose lanes, or they might be contiguous with the adjacent general-purpose lanes. Barrier-separated preferential lanes might be operated in a constant direction or be operated as reversible lanes. Some reversible preferential lanes on a divided highway might be operated counter-flow to the direction of traffic on the immediately adjacent general purpose lanes. See [Section 1A.13 of this Supplement](#) for definitions of terms.
- 02 Preferential lanes might be operated full-time (24 hours per day on all days), for extended periods of the day, part-time (restricted usage during specific hours on specified days), or on a variable basis (such as a strategy for a managed lane).

**Standard:**

- 03 **Longitudinal pavement markings for preferential lanes shall be as follows (these same requirements are presented in tabular form in Table 3D-1):**
  - A. **Barrier-separated, non-reversible preferential lane—the longitudinal pavement markings for preferential lanes that are physically separated from the other travel lanes by a barrier or median shall consist of a normal solid single yellow line at the left-hand edge of the travel lane(s), and a normal solid single white line at the right-hand edge of the travel lane(s) (see Drawing A in Figure 3D-1).**
  - B. **Barrier-separated, reversible preferential lane—the longitudinal pavement markings for reversible preferential lanes that are physically separated from the other travel lanes by a barrier or median shall consist of a normal solid single white line at both edges of the travel lane(s) (see Drawing B in Figure 3D-1).**
  - C. **Buffer-separated (left-hand side) preferential lane—the longitudinal pavement markings for a full-time or part-time preferential lane on the left-hand side of and separated from the other travel lanes by a neutral buffer space shall consist of a normal solid single yellow line at the left-hand edge of the preferential travel lane(s) and one of the following at the right-hand edge of the preferential travel lane(s):**
    1. **A wide solid double white line along both edges of the buffer space where crossing the buffer space is prohibited (see Drawing A in [Figure 3D-2\(VA\) in this Supplement](#)).**
    2. **A wide solid single white line along both edges of the buffer space where crossing the buffer space is discouraged (see Drawing B in [Figure 3D-2\(VA\) in this Supplement](#)).**
    3. **A wide broken single white line along both edges of the buffer space, or a wide broken single white lane line within the allocated buffer space (resulting in wider lanes), where crossing the buffer space is permitted (see Drawing C in [Figure 3D-2\(VA\) in this Supplement](#)).**

- D. Buffer-separated (right-hand side) preferential lane**—the longitudinal pavement markings for a full-time or part-time preferential lane on the right-hand side of and separated from the other travel lanes by a neutral buffer space shall consist of a normal solid single white line at the right-hand edge of the preferential travel lane(s) if warranted (see [Section 3B.07 in this Supplement](#)) and one of the following at the left-hand edge of the preferential travel lane(s) (see Drawing D in [Figure 3D-2\(VA\) in this Supplement](#)):
1. A wide solid double white line along both edges of the buffer space where crossing the buffer space is prohibited.
  2. A wide solid single white line along both edges of the buffer space where crossing of the buffer space is discouraged.
  3. A wide broken single white line along both edges of the buffer space, or a wide broken single white line within the allocated buffer space (resulting in wider lanes), where crossing the buffer space is permitted.
  4. A wide dotted single white lane line within the allocated buffer space (resulting in wider lanes) where crossing the buffer space is permitted for any vehicle to perform a right-turn maneuver.
- E. Contiguous (left-hand side) preferential lane**—the longitudinal pavement markings for a full-time or part-time preferential lane on the left-hand side of and contiguous to the other travel lanes shall consist of a normal solid single yellow line at the left-hand edge of the preferential travel lane(s) and one of the following at the right-hand edge of the preferential travel lane(s):
1. A wide solid double white lane line where crossing is prohibited (see Drawing A in [Figure 3D-3](#)).
  2. A wide solid single white lane line where crossing is discouraged (see Drawing B in [Figure 3D-3](#)).
  3. A wide solid single white lane line where crossing is permitted (see Drawing C in [Figure 3D-3](#)).
- F. Contiguous (right-hand side) preferential lane**—the longitudinal pavement markings for a full-time or part-time preferential lane on the right-hand side of and contiguous to the other travel lanes shall consist of a normal solid single white line at the right-hand edge of the preferential travel lane(s) if warranted (see [Section 3B.07 of this Supplement](#)) and one of the following at the left-hand edge of the preferential travel lane(s) (see Drawing D in [Figure 3D-3](#)):
1. A wide solid double white lane line where crossing is prohibited.
  2. A wide solid single white lane line where crossing is discouraged.
  3. A wide broken single white lane line where crossing is permitted.
  4. A wide dotted single white lane line where crossing is permitted for any vehicle to perform a right-turn maneuver.

## Figure 3D-1. Markings for Barrier Separated Preferential Lanes



### Guidance:

- 04 Where preferential lanes and other travel lanes are separated by a buffer space, the buffer space should be a minimum of 4 feet wide. Where preferential lanes and other travel lanes are separated by a buffer space wider than 4 feet and crossing the buffer space is prohibited, chevron markings (see [Section 3B.24 of this Supplement](#)) should be placed in the buffer area (see [Drawing A in Figure 3D-2\(VA\) in this Supplement](#)). The chevron spacing should be 100 feet or greater.

### Option:

- 05 Tubular markers (see [Chapter 3H](#)) may be used in areas where needed to prevent drivers from entering and exiting at unauthorized locations.
- 06 If a full-time or part-time contiguous preferential lane is separated from the other travel lanes by a wide broken single white line (see [Drawing C in Figure 3D-3](#)), the spacing or skip pattern of the line may be reduced and the width of the line may be increased.

### Standard:

- 07 If there are two or more preferential lanes for traffic moving in the same direction, the lane lines between the preferential lanes shall be normal broken white lines.



- 08 **Preferential lanes for motor vehicles shall also be marked with the appropriate word or symbol pavement markings in accordance with Section 3D.01 of this Supplement and shall have appropriate regulatory signs in accordance with Sections 2G.03 through 2G.07 of the MUTCD.**

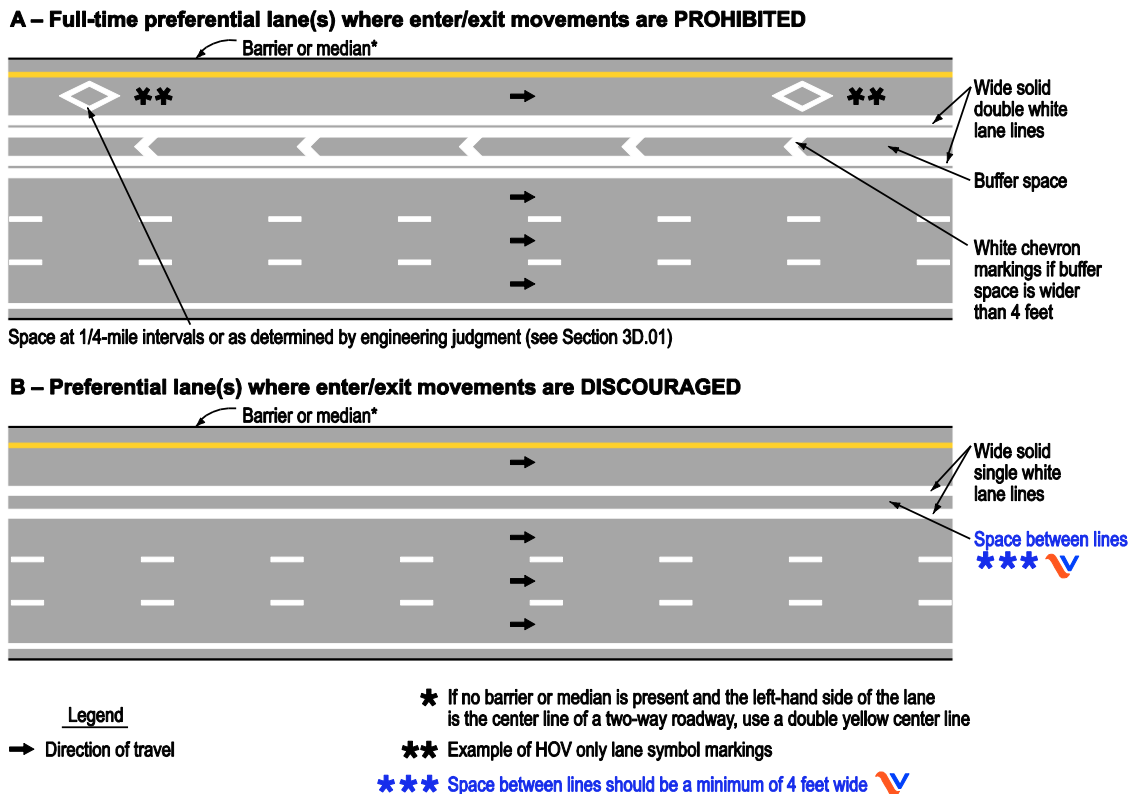
*Guidance:*

- 09 *At direct exits from a preferential lane, dotted white line markings should be used to separate the tapered or parallel deceleration lane for the direct exit (including the taper) from the adjacent continuing preferential through lane, to reduce the chance of unintended exit maneuvers.*

**Standard:**

- 10 **On a divided highway, a part-time counter-flow preferential lane that is contiguous to the travel lanes in the opposing direction shall be separated from the opposing direction lanes by the standard reversible lane longitudinal marking, a normal width broken double yellow line (see Section 3B.03 of the MUTCD and Drawing A of Figure 3D-4). If a buffer space is provided between the part-time counter-flow preferential lane and the opposing direction lanes, a normal width broken double yellow line shall be placed along both edges of the buffer space (see Drawing B of Figure 3D-4). Signs (see Section 2B.26 of the MUTCD), lane-use control signals (see Chapter 4M), or both shall be used to supplement the reversible lane markings.**

**Figure 3D-2(VA). Markings for Buffer Separated Preferential Lanes (Sheet 1 of 2)**



## Table 3D-1. Standard Edge Line and Lane Line Markings for Preferential Lanes

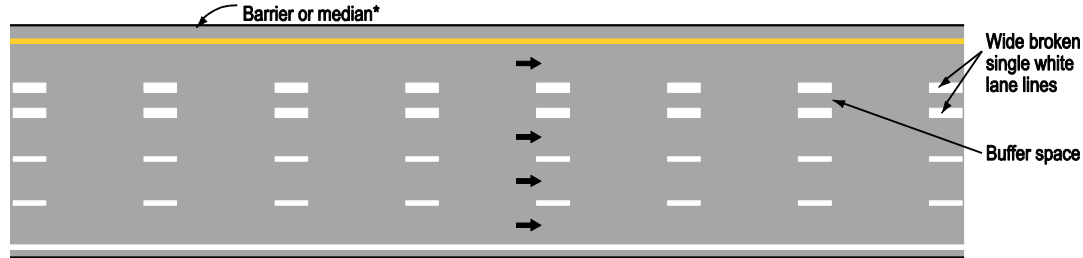
Type of Preferential Lane	Left-Hand Edge Line	Right-Hand Edge Line
<b>Barrier-Separated, Non-Reversible</b>	A normal solid single yellow line	A normal solid single white line (see Drawing A of Figure 3D-1)
<b>Barrier-Separated, Reversible</b>	A normal solid single white line	A normal solid single white line (see Drawing B of Figure 3D-1)
<b>Buffer-Separated, Left-Hand Side</b>	A normal solid single yellow line	<p>A wide solid double white line along both edges of the buffer space where crossing is prohibited (see Drawing A of <a href="#">Figure 3D-2(VA) in this Supplement</a>)</p> <p>A wide solid single white line along both edges of the buffer space where crossing is discouraged (see Drawing B of <a href="#">Figure 3D-2(VA) in this Supplement</a>)</p> <p>A wide broken single white line along both edges of the buffer space, or a wide broken single white line within the buffer space (resulting in wider lanes), where crossing is permitted (see Drawing C of <a href="#">Figure 3D-2(VA) in this Supplement</a>)</p>
<b>Buffer-Separated, Right-Hand Side</b>	<p>A wide solid double white line along both edges of the buffer space where crossing is prohibited (see Drawing D of <a href="#">Figure 3D-2(VA) in this Supplement</a>)</p> <p>A wide solid single white line along both edges of the buffer space where crossing is discouraged (see Drawing D of <a href="#">Figure 3D-2(VA) in this Supplement</a>)</p> <p>A wide broken single white line along both edges of the buffer space, or a wide broken single white line within the buffer space (resulting in wider lanes), where crossing is permitted (see Drawing D of <a href="#">Figure 3D-2(VA) in this Supplement</a>)</p> <p>A wide dotted single white line within the buffer space (resulting in wider lanes) where crossing is permitted for any vehicle to perform a right-turn maneuver (see Drawing D of <a href="#">Figure 3D-2(VA) in this Supplement</a>)</p>	A normal solid single white line (if warranted)
<b>Contiguous, Left-Hand Side</b>	A normal solid single yellow line	<p>A wide solid double white line where crossing is prohibited (see Drawing A of Figure 3D-3)</p> <p>A wide solid single white line where crossing is discouraged (see Drawing B of Figure 3D-3)</p> <p>A wide broken single white line where crossing is permitted (see Drawing C of Figure 3D-3)</p>
<b>Contiguous, Right-Hand Side</b>	<p>A wide solid double white line where crossing is prohibited (see Drawing D of Figure 3D-3)</p> <p>A wide solid single white line where crossing is discouraged (see Drawing D of Figure 3D-3)</p> <p>A wide broken single white line where crossing is permitted (see Drawing D of Figure 3D-3)</p> <p>A wide dotted single white line where crossing is permitted for any vehicle to perform a right-turn maneuver (see Drawing D of Figure 3D-3)</p>	A normal solid single white line

## Notes:

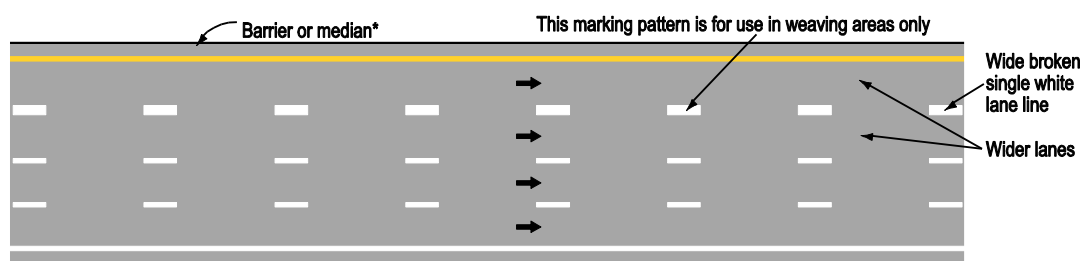
1. If there are two or more preferential lanes, the lane lines between the preferential lanes shall be normal broken white lines.
2. The standard lane markings listed in this table are provided in a tabular format for reference.
3. This information is also described in Paragraph 3 of [Section 3D.02 in this Supplement](#).

## Figure 3D-2(VA). Markings for Buffer Separated Preferential Lanes (Sheet 2 of 2)

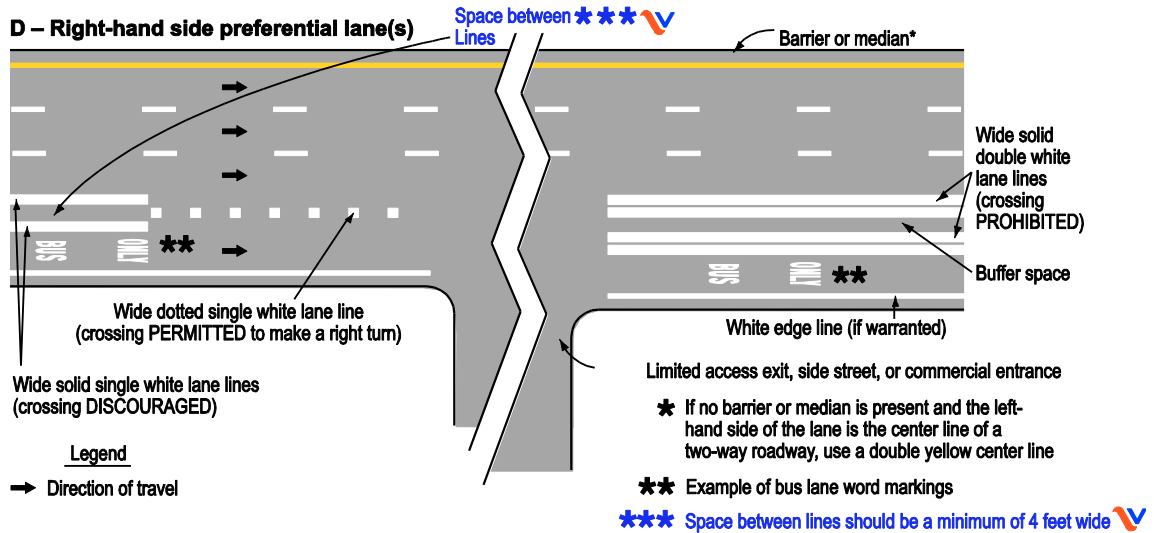
### C – Preferential lane(s) where enter/exit movements are PERMITTED



OR



### D – Right-hand side preferential lane(s)



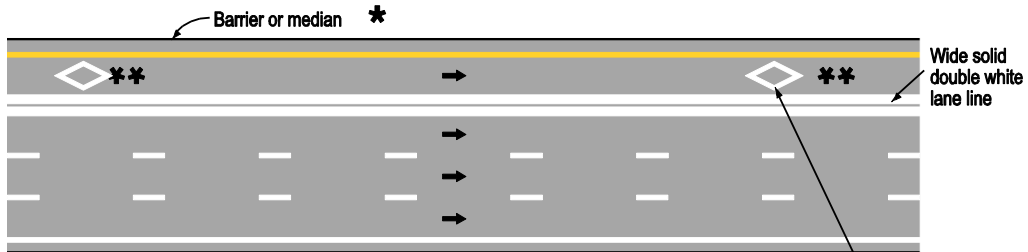
- 11 On a divided highway, a full-time counter-flow preferential lane that is contiguous to the travel lanes in the opposing direction shall be separated from the opposing direction lanes by a solid double yellow center line marking (see Drawing C of Figure 3D-4). If a buffer space is provided between the full-time counter-flow preferential lane and the opposing direction lanes, a normal width solid double yellow line shall be placed along both edges of the buffer space (see Drawing D of Figure 3D-4).

Option:

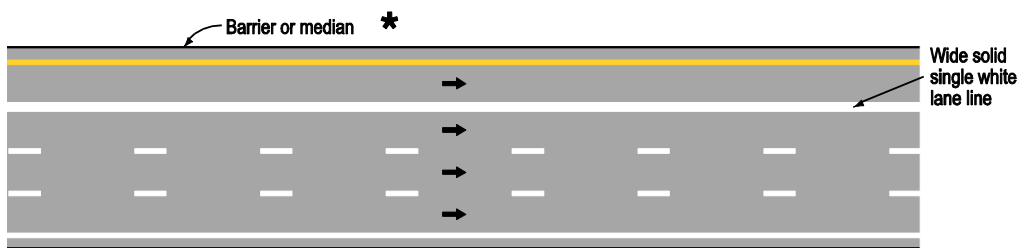
- 12 Cones, tubular markers, or other channelizing devices (see Chapter 3H) may also be used to separate the opposing lanes when a counter-flow preferential lane operation is in effect.

### Figure 3D-3. Markings for Contiguous Preferential Lanes

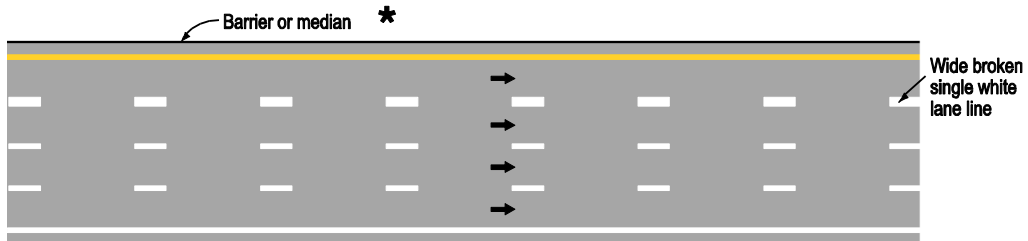
**A – Full-time preferential lane(s) where enter/exit movements are PROHIBITED**



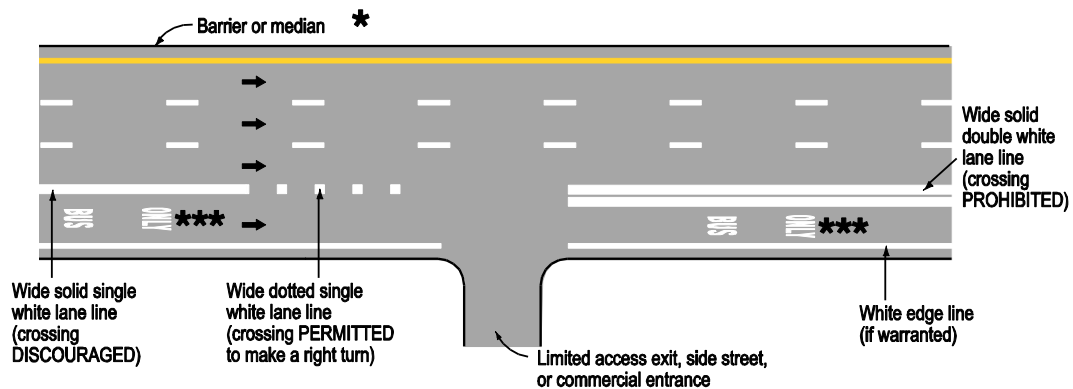
**B – Preferential lane(s) where enter/exit movements are DISCOURAGED**



**C – Preferential lane(s) where enter/exit movements are PERMITTED**



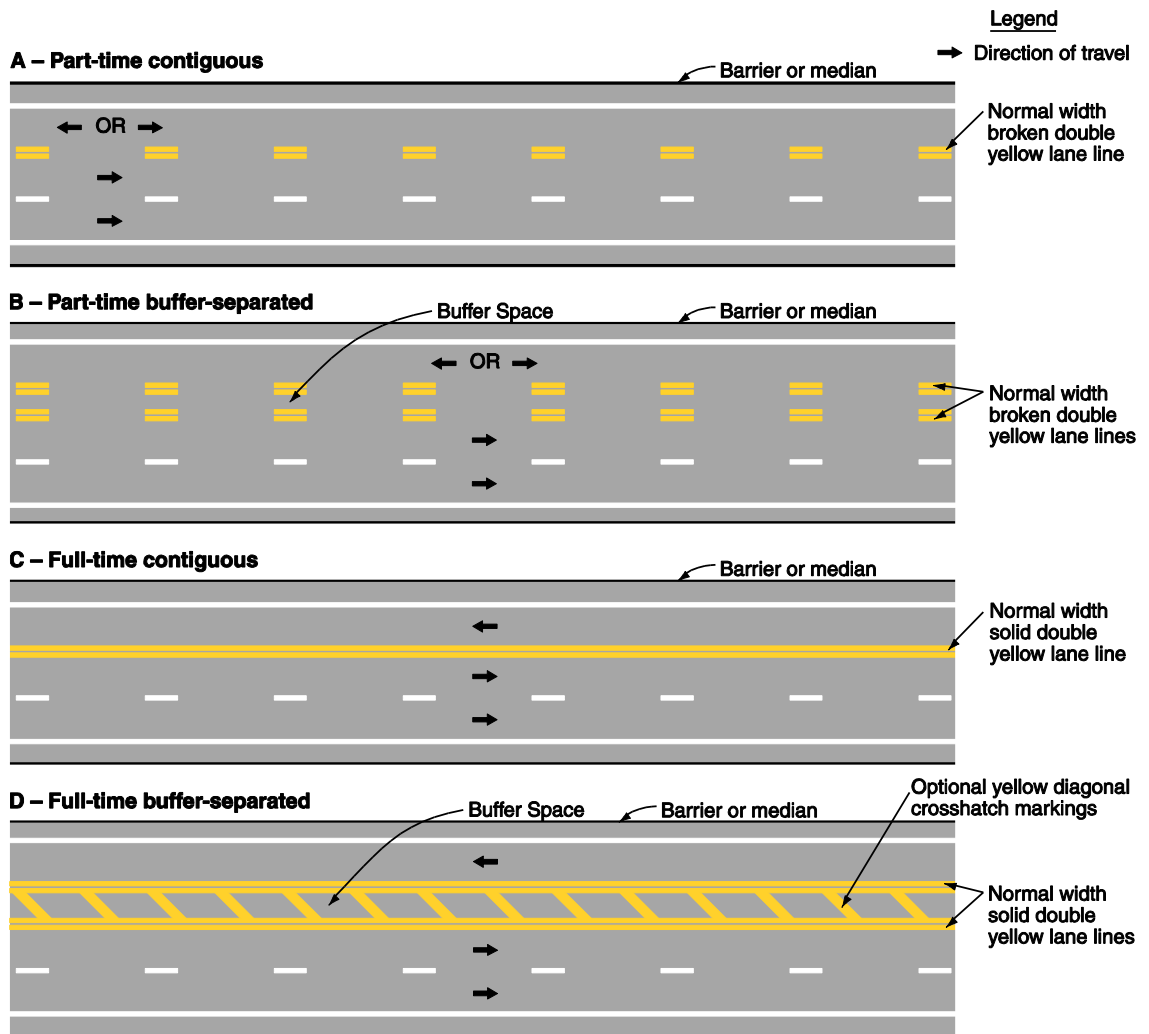
**D – Right-hand side preferential lane(s)**



**Legend**  
 → Direction of travel

- \* If no barrier or median is present and the left-hand side of the lane is the center line of a two-way roadway, use a double yellow center line
- \*\* Example of HOV only lane symbol markings
- \*\*\* Example of bus lane word markings

### Figure 3D-4. Markings for Counter-Flow Preferential Lanes on Divided Highways





## CHAPTER 3F. DELINEATORS

### Section 3F.02 Delineator Design

**Standard:**

- 01 Delineators shall consist of retroreflective devices that are capable of clearly retroreflecting light under normal atmospheric conditions from a distance of 1,000 feet when illuminated by the high beams of standard automobile lights.



- 02 **Retroreflective elements for delineators shall be Type I or Type II design as described below.**

**Support:**

- 03 Within a series of delineators along a roadway, delineators for a given direction of travel at a specific location are referred to as D-1 delineators if they have one square or circular retroreflective element for that direction. The delineators are referred to as D-2 delineators if they have two identical Type II D-1 retroreflective elements mounted together, or a vertically elongated Type I D-1 delineator such that the vertical dimension is twice that of a Type I D-1 delineator.

### Section 3F.03 Delineator Application

**Standard:**

- 01 The color of delineators shall comply with the color of edge lines stipulated in **Section 3B.06 of this Supplement**.



- 02 A series of **D-1 delineators** shall be provided on the right-hand side of freeways and expressways and on at least one side and on the outside of curve of interchange ramps, except when Condition A, Condition B, or Condition C is met, as follows:

- A. On tangent sections of freeways and expressways when both of the following conditions are met:

1. Raised pavement markers are used continuously on lane lines throughout all curves and on all tangents to supplement pavement markings, and
2. Roadside delineators are used to lead into all curves.

- B. On sections of roadways where continuous lighting is in operation between interchanges.

- C. **Roadways where delineators are installed on guardrails, parapets, and barriers adjacent to the roadway.**

**Option:**

- 03 Delineators may be provided on other classes of roads. A series of **D-1 delineators** may be provided on the left-hand side of roadways.

**Standard:**

04 **Delineators on the left-hand side of a two-way roadway shall be white (see Figure 3F-1).**

05 **A series of D-1 delineators shall be provided on the outside of curves on interchange ramps.**

06 **Where median crossovers are provided for official or emergency use on divided highways and where these crossovers are to be marked, yellow D-2 delineators shall be placed on the left-hand side of the through roadway on the far side of the crossover for each roadway.**

07 **D-2 delineators shall be installed at 100-foot intervals along acceleration and deceleration lanes.**

08 **Delineators shall be installed on barriers and guardrails that are within 15 feet of the edge of pavement.**

*Guidance:*

09 *A series of delineators should be used wherever guardrail or other longitudinal barriers are present along a roadway or ramp.*

*Option:*

10 Red delineators may be used on the reverse side of any delineator where it would be viewed by a road user traveling in the wrong direction on that particular ramp or roadway.

11 Delineators of the appropriate color may be used to indicate a lane-reduction transition where either an outside or inside lane merges into an adjacent lane.

*Guidance:*

12 *When used for lane-reduction transitions, the delineators should be installed adjacent to the lane or lanes reduced for the full length of the transition and should be so placed and spaced to show the reduction (see Figure 3B-14).*

*Support:*

13 Delineators are not necessary for traffic moving in the direction of a wider pavement or on the side of the roadway where the alignment is not affected by the lane-reduction transition.

*Guidance:*

14 *On a highway with continuous delineation on either or both sides, delineators should be carried through transitions.*

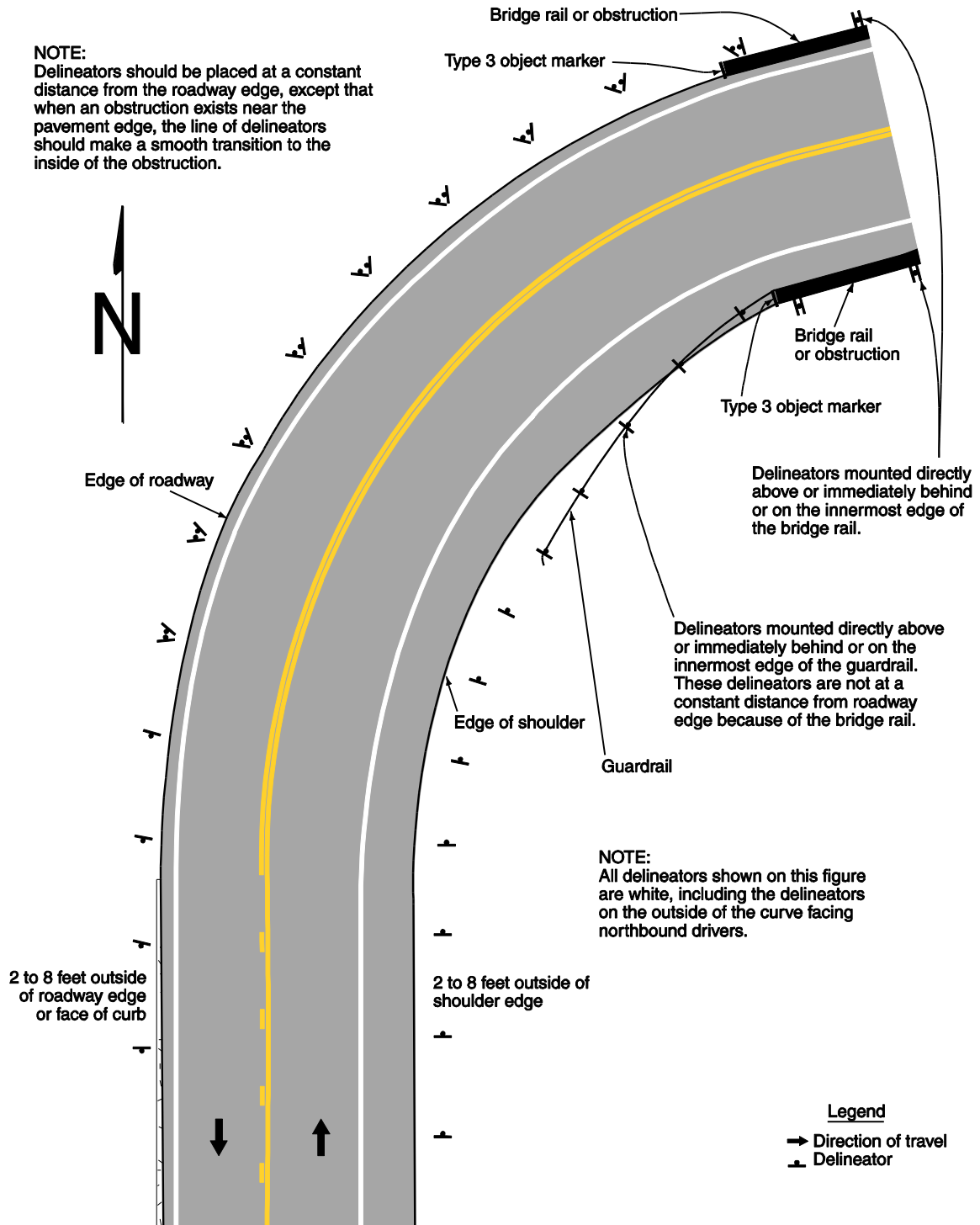
*Option:*

15 On a highway with continuous delineation on either or both sides, the spacing between a series of delineators may be closer.

**Standard:**

16 **When used on a truck escape ramp, delineators shall be red.**

**Figure 3F-1. Examples of Delineator Placement**



*Guidance:*

- 17 *Red delineators should be placed on both sides of truck escape ramps. The delineators should be spaced at 50-foot intervals for a distance sufficient to identify the ramp entrance. Delineator spacing beyond the ramp entrance should be adequate for guidance according to the length and design of the escape ramp.*

**Section 3F.04 Delineator Placement and Spacing***Guidance:*

- 01 *Delineators should be mounted on suitable supports at a mounting height, measured vertically from the bottom of the lowest retroreflective device to the elevation of the near edge of the roadway, of approximately 4 feet.*

*Option:*

- 02 *When mounted on the face of or on top of guardrails or other longitudinal barriers, delineators may be mounted at a lower elevation than the normal delineator height recommended in Paragraph 1.*

*Guidance:*

- 03 *When used, road edge delineators should be erected two feet beyond the outer edge of the shoulder or the face of un-mountable curb.*
- 04 *Delineators should be placed at a constant distance from the edge of the roadway, except that where an obstruction intrudes into the space between the pavement edge and the extension of the line of the delineators, the delineators should be transitioned to be in line with or inside the innermost edge of the obstruction. If the obstruction is a guardrail or other longitudinal barrier, the delineators should be transitioned to be just behind, directly above (in line with), or on the innermost edge of the guardrail or longitudinal barrier.*

**Standard:**

- 05 **When used, D-1 delineators shall be placed on the right of through roadways at 528 foot spacing. The spacing along interchange ramps shall be at 100 foot intervals except in horizontal curve sections, where the spacing shown in Table 3F-1 shall be used. D-2 delineators shall be placed on acceleration and deceleration lanes at 100 foot spacing.**
- 06 **Spacing for delineators on barrier or guardrail shall be on 80-foot centers unless otherwise indicated. Delineators mounted on guardrail and barriers located in curves on interchange ramps shall be spaced in accordance with the spacing for interstate road-edge delineators as shown in Table 3F-1 except that the maximum spacing shall be 80 feet. Where the center-to-center spacing for delineators on guardrail cannot be obtained due to post spacing, the delineators shall be installed to provide spacing that is not greater than the spacing indicated herein.**

*Support:*

- 07 *Examples of delineator installations are shown in Figure 3F-1.*

**Option:**

- 08 When uniform spacing is interrupted by such features as driveways and intersections, delineators which would ordinarily be located within the features may be relocated in either direction for a distance not exceeding one quarter of the uniform spacing. Delineators still falling within such features may be eliminated.
- 09 Delineators may be transitioned in advance of a lane transition or obstruction as a guide for oncoming traffic.

**Guidance:**

- 10 *The spacing of delineators should be adjusted on approaches to and throughout horizontal curves so that several delineators are always simultaneously visible to the road user. The approximate spacing shown in Table 3F-1 should be used.*

**Option:**

- 11 When needed for special conditions, delineators of the appropriate color may be mounted in a closely-spaced manner on the face of or on top of guardrails or other longitudinal barriers to form a continuous or nearly continuous "ribbon" of delineation.

**Table 3F-1. Approximate Spacing for Delineators on Horizontal Curves**

Radius (R) of Curve	Approximate Spacing (S) on Curve
50 feet	20 feet
115 feet	25 feet
180 feet	35 feet
250 feet	40 feet
300 feet	50 feet
400 feet	55 feet
500 feet	65 feet
600 feet	70 feet
700 feet	75 feet
800 feet	80 feet
900 feet	85 feet
1,000 feet	90 feet

**Notes:**

- Spacing for specific radii may be interpolated from table.
- The minimum spacing should be 20 feet.
- The spacing on curves should not exceed 300 feet.
- In advance of or beyond a curve, and proceeding away from the end of the curve, the spacing of the first delineator is 2S, the second 3S, and the third 6S, but not to exceed 300 feet.
- S refers to the delineator spacing for specific radii computed from the formula  $S=3\sqrt{R-50}$ .
- The distances for S shown in the table above were rounded to the nearest 5 feet.